

## SISTEMA DE MONTAJE DE 9 PANELES INCLINADO 15 - 30° PARA PANELES DE HASTA 1135MM DE ANCHO

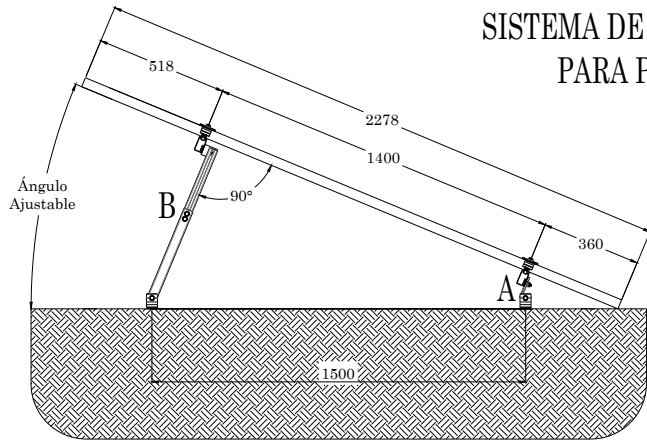

VISTA LATERAL

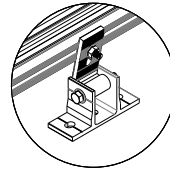

DETALLE A  
Soporte Frontal  
Ajustable

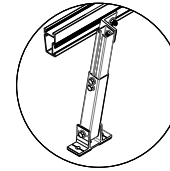

DETALLE B  
Soporte Trasero  
Ajustable

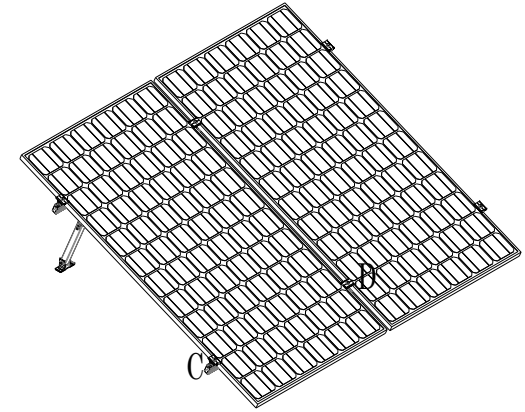

VISTA ISOMÉTRICA

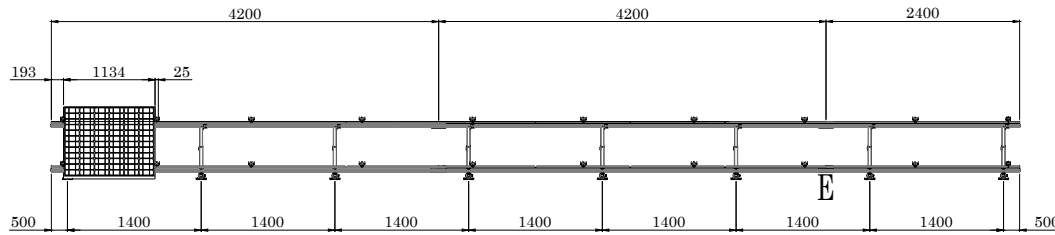

VISTA FRONTAL

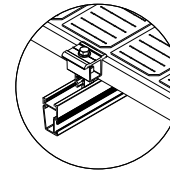

DETALLE C  
Abrazadera  
Universal  
(Modo Remate)

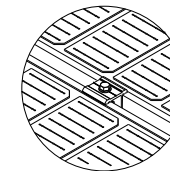

DETALLE D  
Abrazadera  
Universal  
(Modo Intermedio)

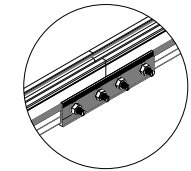

DETALLE E  
Empalme de Riel

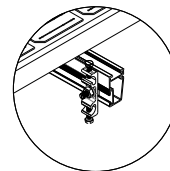

Terminal de  
Conexión a Tierra

NOTA: 1 NXT-RX-4800-MILL se corta a la mitad  
NOTA: Resiste vientos de hasta 160 km/h

# Parte	Descripción	Cantidad
NXT-RX-4200-MILL	Perfil NextRail 4.2m, mill finish, Aluminio 6105-T6	4
NXT-RX-4800-MILL	Perfil NextRail 4.8m, mill finish, Aluminio 6105-T6	1
NXT-ER-2	2 Empalmes de riel con puesta a tierra, para Next-Rail	2
NXT-AUA-30/46-2	2 Abrazadera universal p/panel con marco de 30-46mm	10
NXT-GC-1	1 Terminal de conexión a tierra para Next-Rail	1
NXT-CLIP-5	5 Clips de plástico para dos cables, Next-Rail	5
NXT-SFA-1	1 Soporte frontal ajustable para Next-Rail	8
NXT-STA-15/30-1	1 Soporte trasero ajustable 15-30° para Next-Rail	8

observaciones:		<b>//Aluminext</b> <b>//Next-PVRack</b>	
MATERIAL:		N° DE DIBUJO	A3
FECHA	31/05/2023	NXT-SM9I-30-1135	
ACOT.	mm [in]		
PESO:		ESCALA: NA	H01A1 DE 1