



# Installation / User Manual

## APsystems ECU-R Energy Communication Unit

Rev 1.0 NA 1.0



© All Rights Reserved

# Table of Contents

<b>1. Introduction.....</b>	<b>2</b>
<b>2. Interface Explanation.....</b>	<b>3</b>
2.1 Interface Layout.....	3
2.2 Reset.....	3
2.3 Power Connection Port.....	3
2.4 USB port.....	3
2.5 RJ45 Ethernet Network Port.....	4
2.6 RJ45 Signal (Only for Australia) .....	4
2.7 Antenna.....	4
2.8 LED1.....	4
2.9 LED2.....	4
<b>3. Hardware Installation.....</b>	<b>5</b>
3.1 Preparation.....	5
3.2 Selecting an Installation Location for the ECU-R.....	5
3.3 Installation.....	5
3.4 Cable Connection.....	7
3.5 Antenna.....	8
3.6 Internet Connection.....	9
<b>4. ECU-R User Interface.....</b>	<b>10</b>
4.1 Connecting to the ECU-R via the Local Wireless.....	10
4.2 Managing IDs.....	11
4.3 Home Screen.....	11
4.4 Data.....	12
4.4.1 Real Time Data.....	12
4.4.2 Trend of system power.....	13
4.4.3 Power generation statistics.....	13
4.5 Settings.....	14
4.5.1 Managing IDs.....	14
4.5.2 Changing the Date.....	14
4.5.3 Managing the Network Connection.....	15
4.5.4 Managing the WLAN connection.....	15
4.5.5 WLAN PASSWORD.....	16
4.5.6 Language.....	17
4.5.7 Help.....	17
<b>5. Technical Data.....</b>	<b>18</b>
<b>6. Contact Information.....</b>	<b>20</b>

# 1. Introduction

The APsystems Energy Communication Unit (ECU-R) is the information gateway for our microinverters. The unit collects module performance data from each individual microinverter and transfers this information to an Internet database in real time, requiring only a single data and power cable. Through the APsystems Energy Monitoring and Analysis software, the ECU-R gives you precise analysis of each microinverter and module in your solar installation ECU APP. The user-friendly interface lets you access your solar array in seconds.

## Features

- Collects individual module and microinverter statistics
- Communicates in real time
- Requires no additional wiring

The APsystems ECU-R is used in utility-interactive grid-tied applications, and is made up of four key elements:

- APsystems Microinverter
- APsystems Energy Communication Unit (ECU-R)
- APsystems APP (ECU APP)  
Based on Android and iOS.
- APsystems Energy Monitoring and Analysis (EMA)  
Web-based monitoring and analysis system.

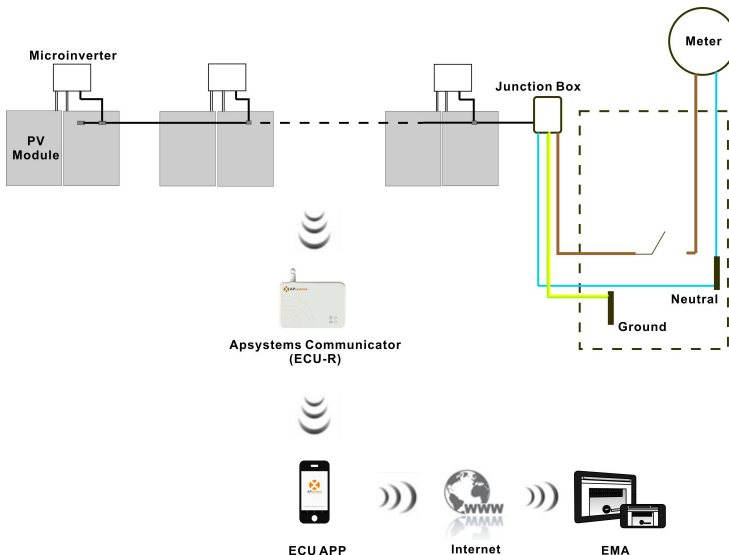

Figure 1

## 2. Interface Explanation

### 2.1 Interface Layout

The ECU-R interface includes, from left to right, are Reset, power connection port, USB port, RJ45 Internet, RJ45 Signal port and antenna.

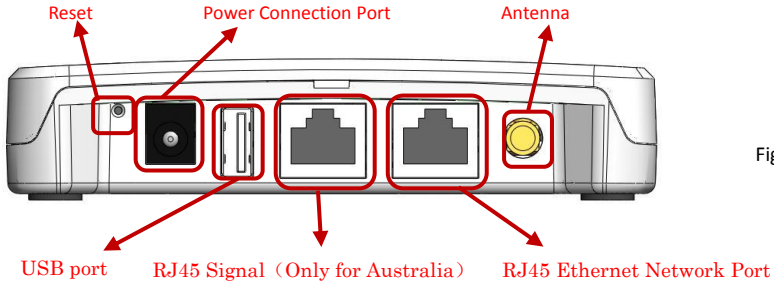

Figure 2

### 2.2 Reset

Press the Reset button for three seconds or longer, and the ECU-R will automatically return to the default settings.

#### NOTICE

The wireless password will be changed to '88888888'.

### 2.3 Power Connection Port

The power connection port connects power through the power adapter.

### 2.4 USB port

The USB interface is reserved.

## 2. Interface Explanation

### 2.5 RJ45 Ethernet Network Port

The ECU-R allows the user to communicate with the EMA

### 2.6 RJ45 Signal (Only for Australia)

The RJ45 Signal is designed for DRM0, it should be connected by RJ45 connector in the package otherwise the inverters will not work.

### 2.7 Antenna

The antenna in the package should be connected to ECU-R.

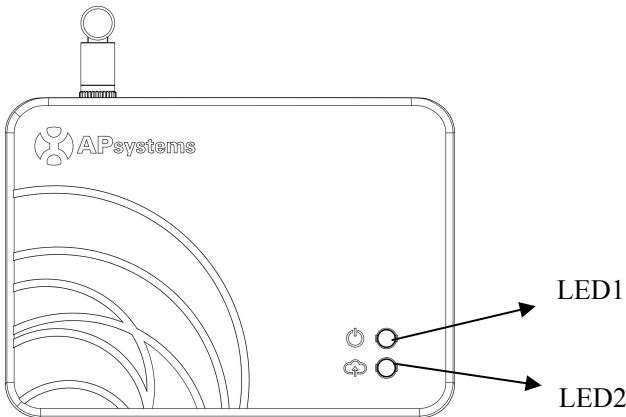

Figure 3

### 2.8 LED1

When the ECU-R works normally, the LED1 is light.

### 2.9 LED2

When the ECU-R works normally, the LED2 will flicker ;  
When the LED2 does not flicker the network is abnormal, please onfirm the network connection.

# 3. Hardware Installation

## 3.1 Preparation

Make sure you have the following components ready before beginning to install the ECU-R:

- A dedicated standard AC electrical outlet (located as close to the array as is possible).
- A broadband Internet connection available for your use.
- A broadband router with either a CAT5 Ethernet, or a wireless router.
- A smart phone with ECU APP.(see page 10)

## 3.2 Selecting an Installation Location for the ECU-R

- Choose a location that is as close to the array as possible
- The ECU-R is NOT rated for outdoor use, so if installing outdoors near a junction box or breaker panel, make sure you enclose it in an appropriate weatherproof NEMA electrical box.

## 3.3 Installation

### 1) Using a Wall Mount

When mounting the ECU-R to a wall, make sure to select a cool, dry indoor location.

- Depending on the wall surface you are mounting the ECU-R to, use either two (2) #8 drywall screws or wall anchors, installed 100 mm apart. The drywall screws and wall anchors are NOT included in the ECU-R kit.
- Align and slide the ECU-R onto the mounting screws.

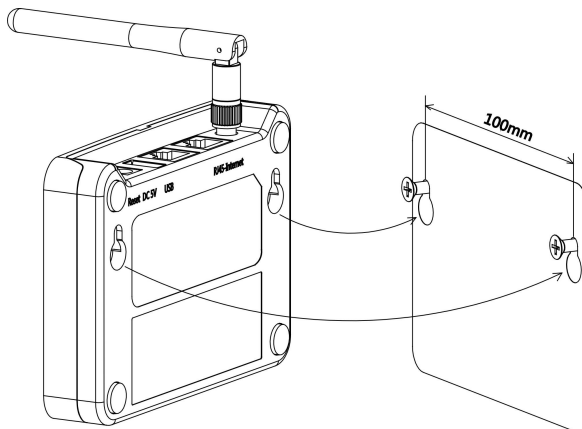

Figure 4

### 3. Hardware Installation

#### 2) Power Distribution Cabinet Installation

If you use the energy communicator in power distribution cabinet:

- Install the two Guide rail fasteners on the guide rail 100 mm apart .
- Align and slide the ECU-R onto the two Guide rail fasteners.

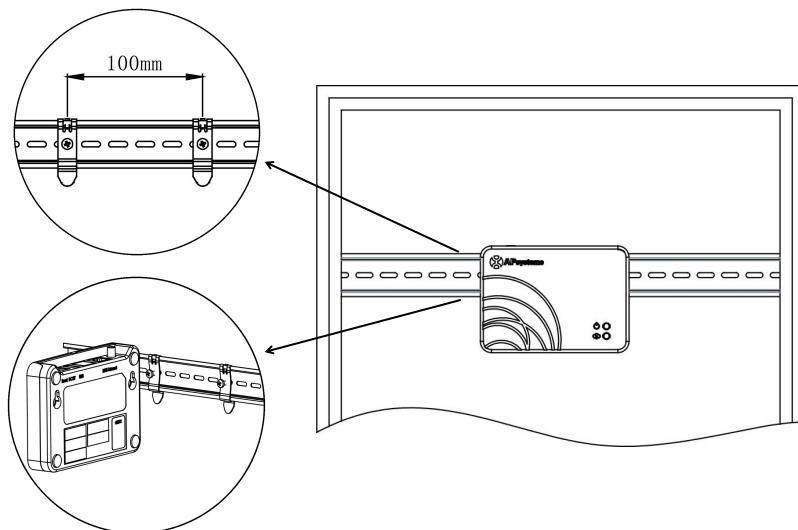

Figure 5

## 3. Hardware Installation

### 3.4 Cable Connection

#### 1) Using a Wall Mount

- Connect the adapter to the power connection port on the top of the ECU-R.

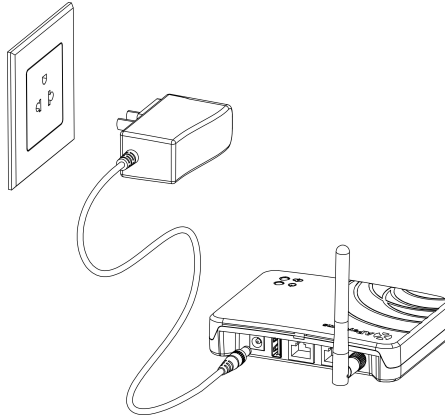

Figure 6

#### 2) Power Distribution Cabinet Installation

- Guide rail type socket installation (The guide rail type socket is not supplied by APsystem).
- Connect the adapter to the power connection port on the top of the ECU-R.

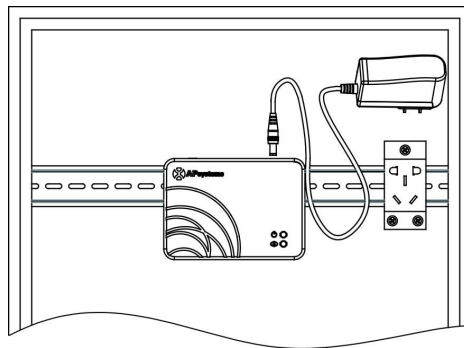

Figure 7



## 3. Hardware Installation

### 3.5 Antenna

- Make sure the antenna is properly connected to corresponding position on the top of the ECU-R.
- Connect the antenna to the RF port of the ECU-R, The antenna must be placed outside the Power Distribution Cabinet.

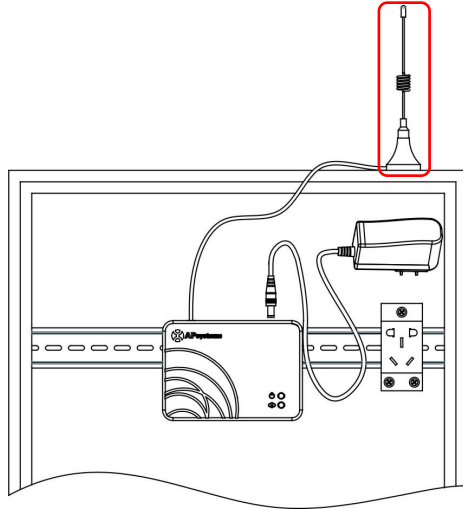

Figure 8



#### NOTICE

Do not put the antennas inside a metal box, that will block the signal.

## 3. Hardware Installation

### 3.6 Internet Connection

There are two different approaches to connecting the ECU-R to the Internet:

Option 1: Direct LAN cable connection.

- 1) Make sure the LAN cable is connected to the network port on the bottom of the ECU-R.
- 2) Connect the LAN cable to a spare port on the broadband router.



Figure 9

Option 2: Wireless Connection.

Use ECU-R internal WLAN (see Managing the WLAN Connection).

## 4. ECU-R User Interface

Please scan the QR code to get ECU APP :



( ios )



( Android )

### 4.1 Connecting to the ECU-R via the Local Wireless

- Open the ECU APP.
- Open the WLAN, link the WiFi of ECU-R, the default password is “88888888”.

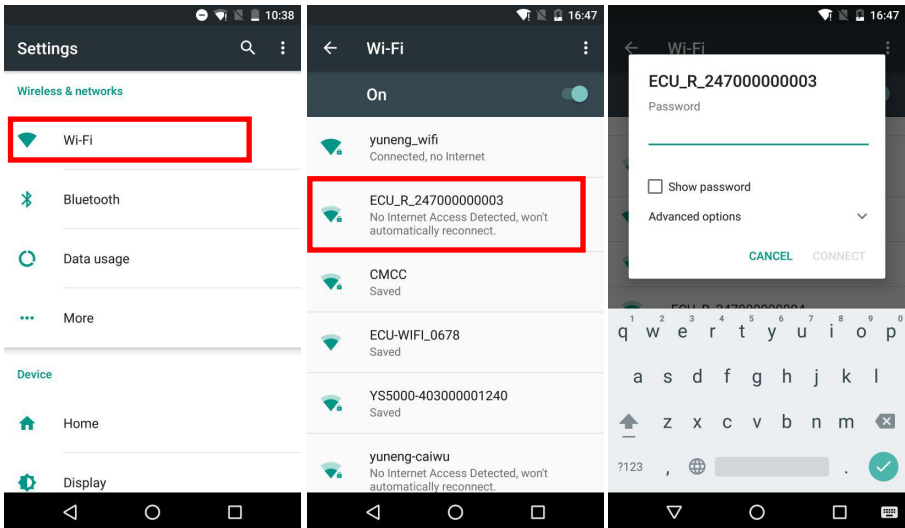

## 4. ECU-R User Interface

### 4.2 Managing IDs

- Click settings, select the ID management, input the ID ,click OK to complete. If you want to clean up all the IDs, please click “CLEAR ID “.

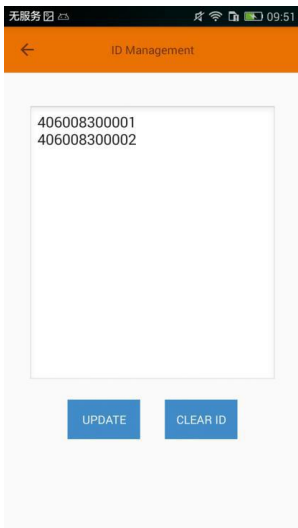

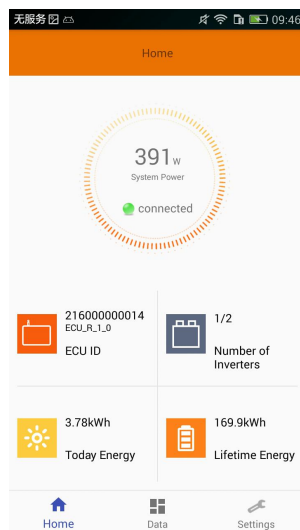

### 4.3 Home Screen

- Select “Home” at the bottom of the page. The Home Page is displayed.



## 4. ECU-R User Interface

-  Green light indicates the mobile phone is connected to the ECU-R.
-  Grey light indicates the mobile phone disconnects with ECU-R.

### 4.4 Data

#### 4.4.1 Real Time Data

- To view the real-time system operation data statistics for your solar array, click “Real Time Data” from the ECU-R home screen to navigate to the real-time data screen.
- Click component, you can see the the specific information of the inverter, including the inverter ID, the PV module power, voltage, frequency and temperature.

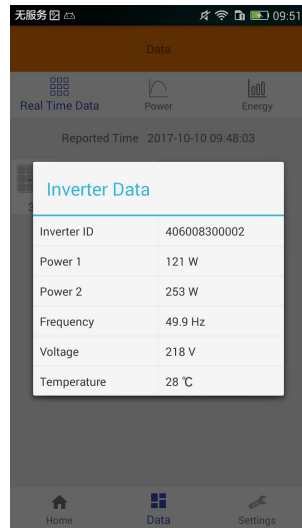
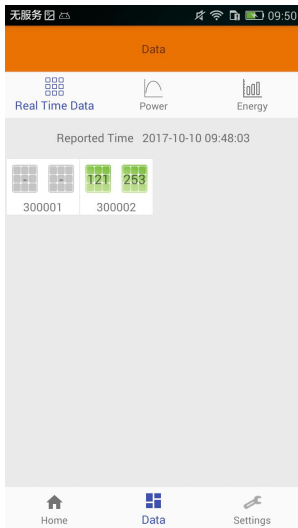

Green panel indicates the inverter is connected.



Grey panel indicates the inverter is disconnected.

## 4. ECU-R User Interface

### 4.4.2 Trend of system power

- To view the system power of any period, click "Power" at the real-time data page. The Trend of system power screen is displayed.



### 4.4.3 Power generation statistics

- Press "Energy" at the real-time data page to view the system power generation of your solar array.

The Power generation statistics screen is displayed.  
Performance data for the current week:

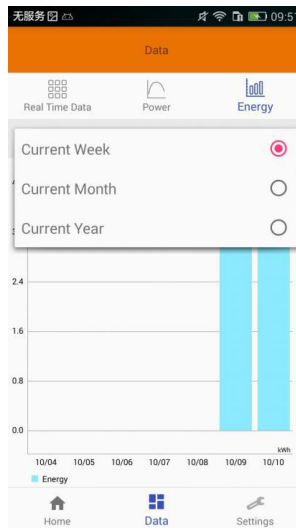
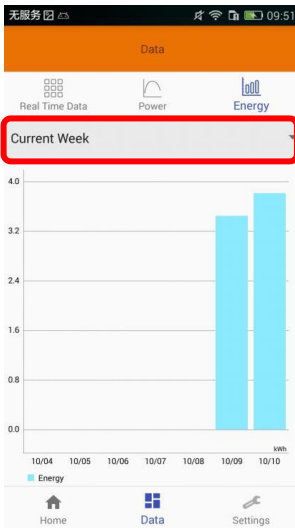

## 4. ECU-R User Interface

### 4.5 Settings

- Click on the settings

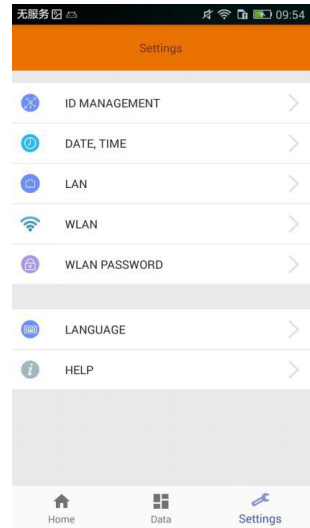

#### 4.5.1 Managing IDs

- This page reference 4.2 Managing IDs.

#### 4.5.2 Changing the Date

- It is critical for accurate power production reporting that the ECU-R is programmed With the correct date, time.

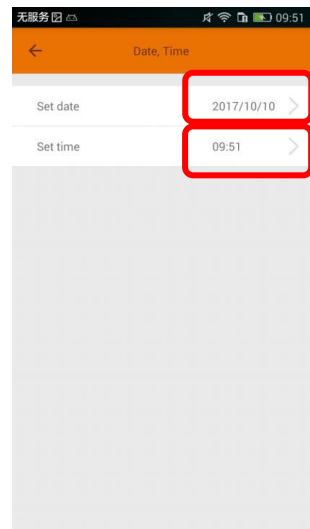

## 4. ECU-R User Interface

### 4.5.3 Managing the Network Connection

- The default network connection setting for the ECU-R is “DHCP,” which allows the ECU-R to automatically establish a connection assignment from the router. The ECU-R can be assigned a static.

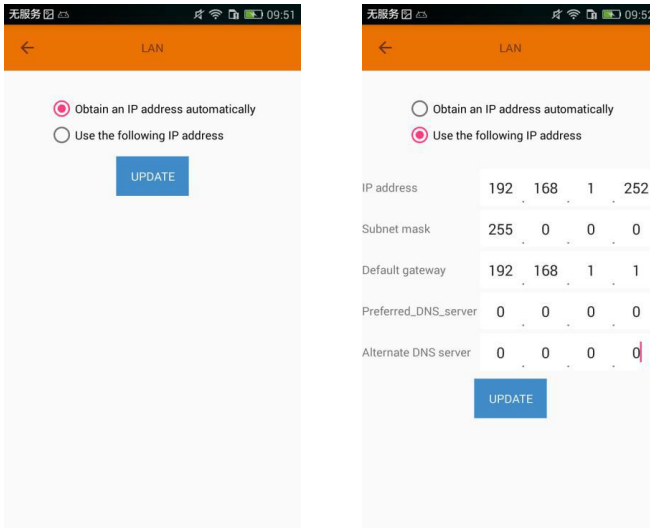

### 4.5.4 Managing the WLAN connection

- Select the button next to the available network that you wish to access SSID, and a password entry field will be displayed below the network name. Enter the password into the password entry field.



## 4. ECU-R User Interface

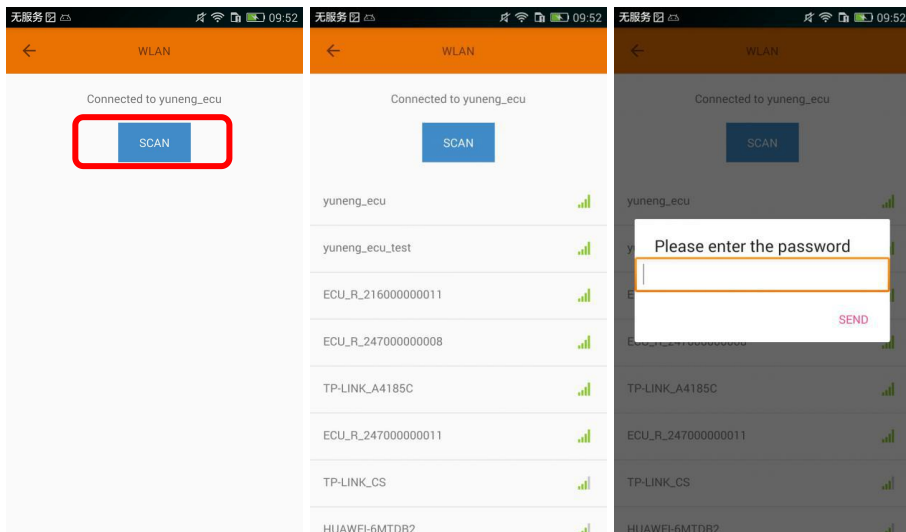

### NOTICE

After the password is sent, ECU-R will restart. Please reconnect to ECU-R.

#### 4.5.5 WLAN PASSWORD

- Please reconnect the ECU-R hotspot after setting the password. On the page, you can modify Password.
- if you forget the "old password", can be carried out on a hardware reset ECU-R, WiFi password recovery for the default password is "88888888".

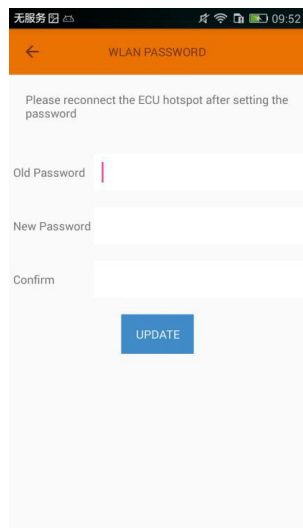

## 4. ECU-R User Interface

### 4.5.6 Language

Switch Language.



### 4.5.7 Help

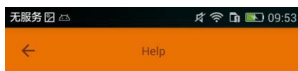

#### Introduction

This App is a smart phone application designed for control and monitor ECU-R. User could get the working status of ECU-R and inverters below it, also could reset the configurations.

#### Main function

Get the latest working status and configurations of ECU-R, monitor each inverter.

Show the real time data, power, and energy in the data page.

Reset inverter IDs to ECU-R, make new communications.

Reset the time on ECU-R, the current time of the ECU-R will be displayed.

Obtain an IP address automatically or use a static IP address.

# 5. Technical Data

<b>Model: ECU-R</b>	
<b>REV 1.0</b>	
<b>Communication Interface</b>	
Integrated Wi-Fi	802.11g/n
Antenna	Standard
<b>Power Requirements</b>	
AC Adapter	110~240 VAC, 50~60 Hz 5V 2A
Power Consumption	1.7W
<b>Mechanical Data</b>	
Dimensions (W×H×D)	122mm×87mm×25mm
Weight	150g
Ambient Temperature Range	-20°C to +65°C
Cooling	Nature Convection; No Fans
Enclosure Environmental Rating	Indoor - NEMA 1(IP20)
<b>Features</b>	
Compliance	IEC 60950-1, EN60950-1, IEC 60529, EN 60529, ANSI/UL 60950-1, CAN/CSA C22.2 No.60950-1, UL50E, FCC part 15, EN61000-6-1,EN61000-6-3, ICES-003, AS NZS 60950-1, GB/T17799

Specifications subject to change without notice.

Please ensure you are using the most recent update found at [www.APsystems.com](http://www.APsystems.com).

This device complies with part 15 of the FCC Rules. Operation is subject to the following two conditions: (1) This device may not cause harmful interference, and (2) this device must accept any interference received, including interference that may cause undesired operation.

This Class B digital apparatus complies with Canadian ICES-003.

2017/11/25 REV1.0

### :: WEEE (for Europe )



#### Disposal of your old appliance

1. When this crossed-out wheeled bin symbol is attached to a product, it means the product is covered by the European Directive 2002/96/EC.
2. All electrical and electronic products should be disposed of separately from the municipal waste stream via designated collection facilities appointed by the government or the local authorities.
3. The correct disposal of your old appliance will help prevent potential negative consequences for the environment and human health.
4. For more detailed information about disposal of your old appliance, please contact your city office, waste disposal service or the shop where you purchased the product.

#### CAUTION

**The professional person is allowed to replace the battery.**

**Do not ingest battery, Chemical Burn Hazard.**

This product contains a coin/button cell battery. If the coin/button cell battery is swallowed, it can cause severe internal burns in just 2 hours and can lead to death. Keep new and used batteries away from children. If you think batteries might have been swallowed or placed inside any part of the body, seek immediate medical attention.

## 6.Contact Information

ALTENERGY POWER SYSTEM Inc.

[www.APsystems.com](http://www.APsystems.com)

### **APsystems Jiaxing China**

No. 1, Yatai Road, Nanhu District, Jiaxing, Zhejiang

Tel: +86 573 8398 6967

Mail: [info@altenergy-power.com](mailto:info@altenergy-power.com)

### **APsystems Shanghai China**

B403 No. 188, Zhangyang Road, Pudong, Shanghai

Tel: +86 021 3392 8205

Mail: [info@altenergy-power.com](mailto:info@altenergy-power.com)

### **APsystems Australia**

Suite 502, 8 Help Street, Chatswood NSW 2067 Australia

Tel: +61 (0)2 8034 6587

Mail: [info@altenergy-power.com](mailto:info@altenergy-power.com)

### **APsystems America**

600 Ericksen Ave NE, Suite 200 Seattle, WA 98110

Tel: 844-666-7035

Mail: [info@APsystems.com](mailto:info@APsystems.com)

### **APsystems Europe**

Rue des Monts dor ZAC de Follieuses Sud-Les Echets 01700 Miribel, France

Tel: +33-481 65 60 40

Mail: [emea@APsystems.com](mailto:emea@APsystems.com)