



**PYLON**TECH

# **LFP Lithium Ion Energy Storage System PowerCube-H1/H2 Operation Manual For EU version**

**Information Version:** AS0MSC100H04  
EU20PIHV1202



This manual introduces PowerCube-H1/H2 from Pylontech. PowerCube-H1/H2 is a high voltage Lithium-Ion Phosphate Battery storage system. Please read this manual before you install the battery and follow the instruction carefully during the installation process. Any confusion, please contact Pylontech immediately for advice and clarification.

## Content

<b>1. SAFETY</b>	<b>1</b>
1.1 Symbol	1
1.2 Reference standards	4
<b>2. SYSTEM INTRODUCE</b>	<b>5</b>
2.1 Product Introduce	5
2.2 specification	5
2.2.1 The parameter of system	6
2.2.2 Battery Module (H48050, H48074)	7
2.2.3 Control Module SC1000 (internal power supply)	10
2.3 System Diagram	14
2.3.1 Multiple battery string parallel connection via CAN communication between MBMS and BMS diagram (battery string qty. ≤6 sets)	14
2.3.2 Diagram between BMS and battery modules	14
<b>3. INSTALLATION</b>	<b>15</b>
3.1 Tools	15
3.2 Safety Gear	16
3.3 System Working Environments Checking	16
3.3.1 Cleaning	16
3.3.2 Temperature	16
3.3.3 Cooling System	16
3.3.4 Heating System	17
3.3.5 Fire-extinguisher System	17
3.3.6 Grounding System	17
3.4 Package Items	17
3.5 Handling and placement	19
3.5.1 Handling and placement of the battery module	19
3.5.2 Handling and placement of the rack	19
3.5.3 The fix and installation of the rack	19
3.5.5 Install the MBMS into a 19' standard rack [On the top of BMS, or use the rack configured by user]	20
3.6 Cables connection	21
3.6.1 Attention:	21
3.6.2 Power and communication cable Connection	22

3.6.3	ADD Switch Setting (Address Assignment)	23
3.6.4	System turns on	25
3.6.5	System turns off	28
<b>4.</b>	<b>SYSTEM DEBUG</b>	<b>29</b>
<b>5.</b>	<b>MAINTENANCE</b>	<b>30</b>
5.1	Trouble Shooting:	30
5.2	Replacement of main component	32
5.2.1	Replacement of Battery Module	32
5.2.2	Replacement of Control Module (BMS)	33
5.2.3	Replacement of 3 <sup>rd</sup> level Control Module (MBMS)	34
5.3	Battery Maintenance	34
<b>6.</b>	<b>REMARKS</b>	<b>35</b>
<b>7.</b>	<b>SHIPMENT</b>	<b>35</b>
	<b>ANNEX 1: CABLE CONNECTION DIAGRAM</b>	<b>36</b>
	<b>ANNEX 2: INSTALLATION AND SYSTEM TURN ON PROGRESS LIST</b>	<b>37</b>
	<b>ANNEX 3: SYSTEM TURN OFF PROGRESS LIST</b>	<b>39</b>

# 1. Safety

The PowerCube-H1/H2 is a high voltage DC system, operated by skilled/qualified personnel only. Read all safety instructions carefully prior to any work and observe them at all times when working on with the system.

## Incorrect operation or work may cause:





- injury or death to the operator or a third party;
- damage to the system hardware and other properties belonging to the operator or a third party.









## Skills of Qualified Personnel



Qualified personnel must have the following skills:

- Training in the installation and commissioning of the electrical system, as well as the dealing with hazards;
- Knowledge of the manual and other related documents;
- knowledge of the local regulations and directives.

### 1.1 Symbol

	<b>Danger</b>	<b>Lethal voltage!</b> <ul style="list-style-type: none"><li>● <b>Battery strings will produce high voltage DC power and can cause a lethal voltage and an electric shock.</b></li><li>● <b>Only qualified person can perform the wiring of the battery strings.</b></li></ul>
	<b>Warning</b>	<b>Risk of battery system damage or personal injury</b> <ul style="list-style-type: none"><li>● <b>DO not pull out the connectors while the system is working!</b></li><li>● <b>De-energize from all multiple power sources and verify that there is no voltage.</b></li></ul>
	<b>Caution</b>	<b>Risk of battery system failure or life cycle reduces.</b>
	<b>Symbol in label</b>	<b>Read the product and operation manual before operating the battery system!</b>

	Symbol in label	Danger! Safety!
	Symbol in label	Warning electric shock!
	Symbol in label	Do not place near flammable material
	Symbol in label	Do not reverse connection the positive and negative.
	Symbol in label	Do not place near open flame
	Symbol in label	Do not place at the children and pet touchable area.
	Symbol in label	Recycle label.
	Symbol in label	Label for Waste Electrical and Electronic Equipment (WEEE) Directive (2012/19/EU)

	<p>Symbol in label</p>	<p>The certificate label for EMC.</p>
	<p>Symbol in label</p>	<p>The certificate label for Safety by TÜV SÜD.</p>
	<p>Symbol in label</p>	<p>The certificate label for Safety by TÜV Rheinland.</p>



**Danger:** Batteries deliver electric power, resulting in burns or a fire hazard when they are short circuited, or wrongly installed.



**Danger:** Lethal voltages are present in the battery terminals and cables. Severe injuries or death may occur if the cables and terminals are touched.



**Warning:** DO NOT open or deform the battery module.

**Warning:** Whenever working on the battery, wear suitable personal protective equipment (PPE) such as rubber gloves, rubber boots and goggles.



**Warning:** PowerCube-H1/H2 system working temperature range: 0 °C ~ 50 °C ; Optimum temperature: 18°C~28°C. Out of the working temperature range may cause the battery system over / low temperature alarm or protection which further lead to the cycle life reduction as well as. It will affect the warranty terms as well.



**Caution:** Improper settings or maintenance can permanently damage the battery.

**Caution:** Incorrect inverter parameters will lead to the premature of battery.

## 1.2 Reference standards

No	Description	Code
1	Safety standard for secondary lithium batteries	IEC62619
2	UN38.3 Safe transport standard	UN38.3
3	CE EMC Standard CE EMC Directive 2014/30/EU	EN IEC 61000-6-1:2019 EN IEC 61000-6-2:2019 EN 61000-6-3:2007+A1 EN 61000-6-4:2007+A1 IEC 61000-6-1:2016 IEC 61000-6-2:2016 IEC 61000-6-3:2006+A1 IEC 61000-6-4:2018
4	Battery Cell safety standard	UL1642
5	Battery Cell safety standard	UL1973
6	Battery Cell safety standard	JIS C 8715-2
7	Battery Cell safety standard	UL9540A
8	safety standard for electrical devices CE LVD Directive 2014/35/EU	IEC62477-1
9	Safety Standard for Lithium Battery (Germany)	VDE-AR-E 2510-50:2017



## 2. System Introduce

### 2.1 Product Introduce

PowerCube-H1/H2 is a high voltage battery storage system based on lithium iron phosphate battery, which is one of the new energy storage products developed and produced by Pylontech. It can be used to support reliable power for various types of equipment and systems. PowerCube-H1/H2 is especially suitable for those application scenes which required high power output, limited installation space, restricted load-bearing and long cycle life.

### 2.2 specification

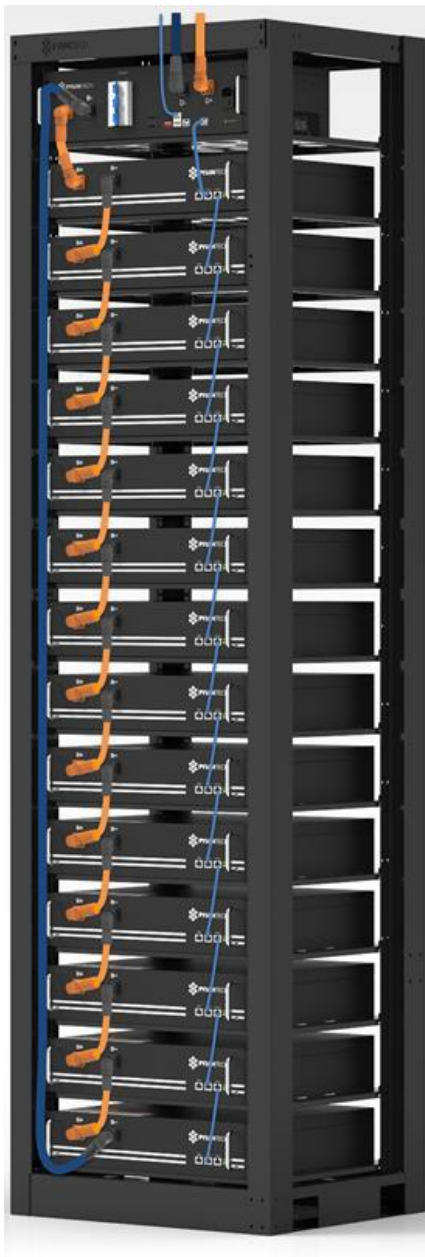

**PowerCube-H1**

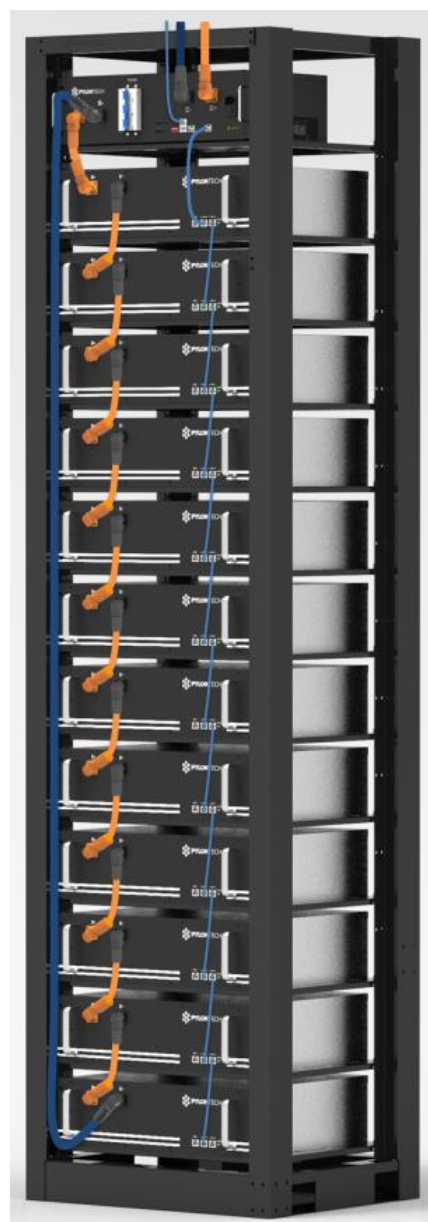

**PowerCube-H2**

### 2.2.1 The parameter of system

Product Type	PowerCube-H1-48/zzzV (zzz=240~864, in step of 48)	PowerCube-H2-48/zzzV (zzz=240~864, in step of 48)
Product Name	LFP Lithium Ion Energy Storage System	LFP Lithium Ion Energy Storage System
Cell Technology	Li-ion(LFP)	Li-ion(LFP)
Battery System Capacity(kWh)	2.4 × n (where n = 5~18)	3.552 × n (where n = 5~18)
Battery System Voltage(Vdc)	48 × n (where n = 5~18)	48 × n (where n = 5~18)
Battery System Capacity(AH)	50Ah	74Ah
Battery Controller Name	SC1000-100	SC1000-100
Battery Module Name	H48050	H48074
Battery Module Quantity(pcs)	n (where n = 5~18)	n (where n = 5~18)
Battery Module Capacity(kWh)	2.4	3.552
Battery Module Voltage(Vdc)	48	48
Battery Module Capacity(AH)	50	74
Battery System Charge Upper-Voltage(Vdc)	54 × n (where n = 5~18)	54 × n (where n = 5~18)
Battery System Charge/Discharge Current*(Standard)	10	14.8
Battery System Charge/Discharge Current*(Normal)	25	37
Battery System Charge/Discharge Current*(Max@15sec)	50	74
Battery System Discharge lower-Voltage(Vdc)	43.5 × n (where n = 5~18)	43.5 × n (where n = 5~18)
Short circuit rating	< 4000	< 4000
Efficiency(@0.5C-rate)	96%	96%
Depth of Discharge	95%	95%
Dimension(W*D*H,mm)	Rack1:600mm(W)*505mm(D)* 2130mm(H) (where n = 5~15) , and Rack2:600mm(W)*505mm(D)* 2130mm(H) (where n = 16~18)	Rack1:600mm(W)*505mm(D)* 2130mm(H) (where n = 5~12), and Rack2:600mm(W)*505mm(D)* 2130mm(H) (where n = 13~18)
Communication	Modbus RTU\CAN	Modbus RTU\CAN
Protection Class	IP20	IP20

Weight (kg)	Rack1: 77kg+ 24kg×n (where n = 5~15) Rack2: 68kg+ 24kg×n (where n = 16~18)	Rack1: 77kg+ 32kg×n (where n = 5~15) Rack2: 68kg+ 32kg×n (where n = 16~18)
Operation Cycle Life	5,000	5,000
Operation Life(Years)	15+	15+
Cooling Type	Nature	Nature
Operation Temperature(°C)	0~50°C	0~50°C
Storage Temperature(°C)	-20~60°C	-20~60°C
Humidity	5~95%	5~95%
Product Certificate	VDE2510-50, IEC62619 , CE EMC, IEC62477-1, UL1973	IEC62619 ,CE EMC, IEC62477-1, UL1973
Transfer Certificate	UN38.3	UN38.3
Other: Battery Controller Dimensions (W*D*H) Battery Module Dimensions (W*D*H)	442*390*132  442*390*100	442*390*132  442*390*132

**Remark:** The parameter will be changed when the battery modules in different series (5~18pcs battery modules).

\*Standard current is for capacity measurement using; Normal current is the operation current sending from BMS; Max. current is the peak current for 15sec.

### 2.2.2 Battery Module (H48050, H48074)



Product Type	H48050
Cell Technology	Li-iron (LFP)
Battery Module Capacity (kWh)	2.4
Battery Module Voltage (Vdc)	48
Battery Module Capacity (AH)	50
Battery Module Charge Voltage (Vdc)	54
Battery System Charge/Discharge Current (Standard)	10
Battery Module Charge/Discharge Current (Normal)	25
Battery Module Charge/Discharge Current (Max.)	50
Battery Module Discharge Voltage (Vdc)	43.5

Dimension (W*D*H, mm)	442*390*100
Communication	RS232 / CAN
Protection Class	IP20
Weight	24
Operation Life	15+Years
Operation Cycle Life	5,000
Operation Temperature	0~50℃
Storage Temperature	-20~60℃
Transportation Certificate	UN38.3



Product Type	H48074
Cell Technology	Li-iron(LFP)
Battery Module Capacity(kWh)	3.552
Battery Module Voltage(Vdc)	48
Battery Module Capacity(AH)	74
Battery Module Charge Voltage(Vdc)	54
Battery Module Charge/Discharge Current(Standard)(A)	14.8
Battery Module Charge/Discharge Current(Normal)(A)	37
Battery Module Charge/Discharge Current(Max.)(A)	74
Battery Module Discharge Voltage(Vdc)	43.5
Dimension(W*D*H, mm)	442*390*132
Communication	RS232\CAN
Protection Class	IP20
Weight(kg)	32
Operation Life(Years)	15+
Operation Cycle Life	5,000
Operation Temperature(℃)	0~50
Storage Temperature(℃)	-20~60
Transportation Certificate	UN38.3

## Battery Module Front Interface



### Power Terminal +/-

To connect battery series power cables.

### Status

Status light: to show the battery module's status (RUN ●, Alarm ● and Protection ●).

### RS232 Terminal

Console Communication Terminal: (RJ45 port) follow RS232 protocol, for manufacturer or professional engineer to debug or service.

### Link Port 0, 1

Link Port 0, 1 Communication Terminal: for communication between multiple serial battery modules and control module.

### Power Terminals

Power cable terminals: there are two pair of terminals with same function, one connects to equipment, the other one paralleling to other battery module for capacity expanding. For each single module, each terminal can achieve charging and discharging function.

For power cables uses AMPHENOL connectors. Must keep pressing the Lock Button during pulling out the power plug.

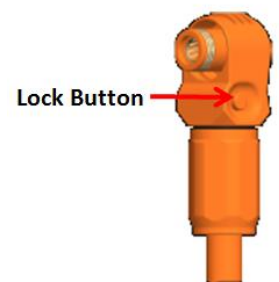

### 2.2.3 Control Module SC1000 (internal power supply)



No.	Product Type	SC1000-100
1	Related Product	H48050/H48074
2	Controller Working Voltage	200~1000Vdc
3	System Operation Voltage(Vdc)	200~1000
4	Charge Current(Max.)(A)	100
5	Discharge Voltage(Vdc)	200~1000
6	Discharge Current(Max.)(A)	100
7	Self-consumption Power(W)	8
8	Dimension(W*D*H,mm)	442*390*132
9	Communication	Modbus RTU\CAN
10	Protection Class	IP20
11	Weight(kg)	8.5
12	Operation Life(Years)	15+
13	Operation Temperature(°C)	-20~65
14	Storage Temperature(°C)	-40~80
15	Product Certificate	TUV, CE

## Control Module (SC1000-100) Front Interface

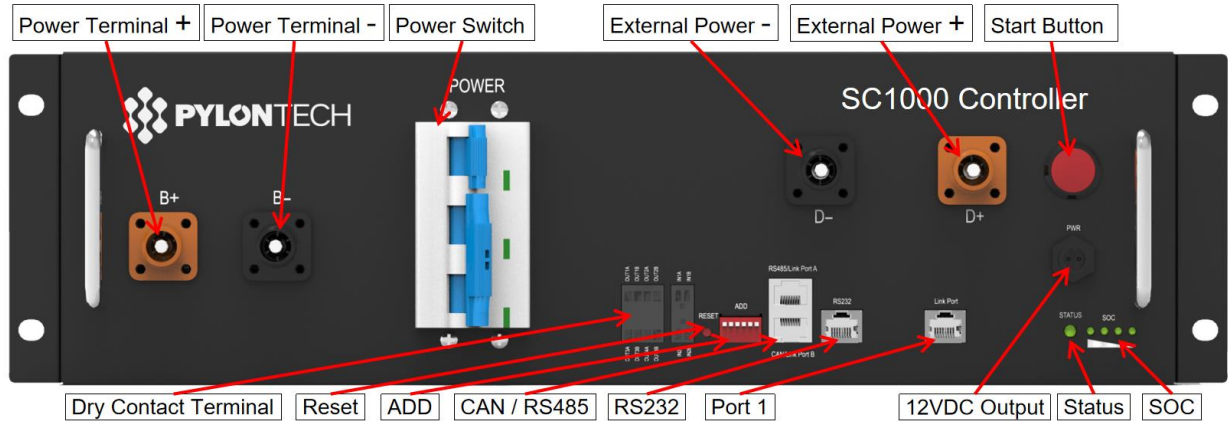

### Power Terminal +/-

To connect battery power cables in series.

### Power Switch



Switch the battery system's (control module and high voltage DC power) ON/OFF.

**Caution:** When the breaker is tripped off because of over current or short circuit, must wait after 30min to turn on it again, otherwise may cause the breaker damage.

### External Power Terminal +/-

Connect battery system with Inverter.

### Dry Contact Terminal

Dry Contact Terminal: provided 2 input and 4 output dry contact signal

Out1	Stop Charge	Always close, when open shall stop charge.
Out2	Stop Discharge	Always close, when open shall stop discharge.
Out3	Error	Always close, when open shall stop operation
Out4	Current Limit	Always close, when open shall limit current to $\leq 0.2C$ -rate
In1	Internal Using ONLY	For wake up signal serial connection using ONLY.
In2	For wake up or For Emergency Stop signal**	Always close, when open will switch off the system.

### Reset

Reset Button: Long press this button to restart the battery system.

## ADD

ADD Switch is a 6 bit dial switches to manually distribute the communication address of the battery system. Nether position is OFF, means "0". Upper position is ON, means "1". For BMS, 1st bit to 5th bit is for address allocation, and the 6th bit dial switch support a 120Ω resistance (Terminal Resistance).

## Start



Start function: press more than 5sec until the buzzer rings, to turn on controller.

Black start function: 30 sec after system turned on and finished self-check process, press and hold the start button again for more than 5sec, after 'STATUS' lamp becomes green, the relay will close and output for 10 min.



开机：长按至蜂鸣器响

Power on: Press and hold  $\geq 5$ sec till the buzzer rings

## CAN / RS485

CAN Communication Terminal: (RJ45 port) follow CAN protocol, for communication between battery system and Inverter.

RS485 Communication Terminal: (RJ45 port) follow Modbus RTU protocol, for communication between battery system and Inverter.

## RS232 Terminal

Console Communication Terminal: (RJ45 port) follow RS232 protocol, for manufacturer or professional engineer to debug or service.

## Link Port 1

Link Port 1 Communication Terminal: (RJ45 port) for communication between multiple serial battery modules and control module.

### Definition of RJ45 Port Pin

No.	CAN	RS485	RS232 Pin
1	---	---	---
2	GND	---	---
3	---	---	TX
4	CANH	---	---
5	CANL	---	---
6	---	GND	RX
7	---	RS485A	---
8	---	RS485B	GND

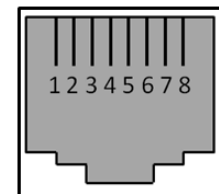

RJ45 Port

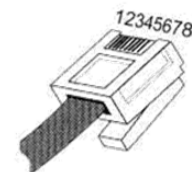

RJ45 Plug



## 12VDC Output Terminal

Power supply for 3<sup>rd</sup> level control module, with 12VDC cable:

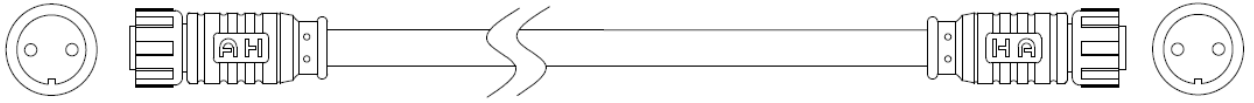

## Status

Status light: to show the battery module's status (RUN●, Alarm● and Protection●).

## LED Status Indicators

Battery capacity indicator: 4 green lamps, each light represents 25% capacity.

## LED Indicators Instructions

Battery Statuses	Protection / Alarm / Normal	RUN	ALM	PRC	Capacity SOC				Descriptions				
		●	●	●	●	●	●	●					
Shut Down		Off	Off	Off	Off	Off	Off	Off	All off				
Sleep	Normal	Flash 1	Off	Off	Off	Off	Off	Off	Indicates Sleep Mode, to save the power.				
Standby	Normal	Flash 1	Off	Off	Off	Off	Off	Off	Indicates save power mode.				
	Alarm	Off	Light	Off	Off	Off	Off	Off	Indicates the battery is low.				
Standby	Normal	Flash 1	Off	Off	Off	Off	Off	Off	Indicates Standby				
Charge	Normal	Light	Off	Off	The highest capacity indicator LED flashes (flash 2), others lighting				The highest capacity indicator LED flashes (flash 2), others lighting				
	Alarm	Off	Light	Off	The highest capacity indicator LED flashes (flash 2), others lighting				The highest capacity indicator LED flashes (flash 2), others lighting				
	Protection	Off	Off	Light	Off	Off	Off	Off	Stop charging, PRC lighting				
Discharge	Normal	Flash 3	Off	Off	Indicate based on capacity				Indicate based on capacity				
	Alarm	Off	Light	Off					Indicate based on capacity				Indicate based on capacity
	Protection	Off	Off	Light									Indicate based on capacity
Abnormal	Protection	Off	Off	Light	Off	Off	Off	Off					

**Note:** The flashing instructions, flash 1 –0.25s light / off 3.75 seconds; flash 2 - 0.5s light / 0.5s off; flash 3 - 0.5s light / 1.5s off.

## 2.3 System Diagram

### 2.3.1 Multiple battery string parallel connection via CAN communication between MBMS and BMS diagram (battery string qty. $\leq 6$ sets)

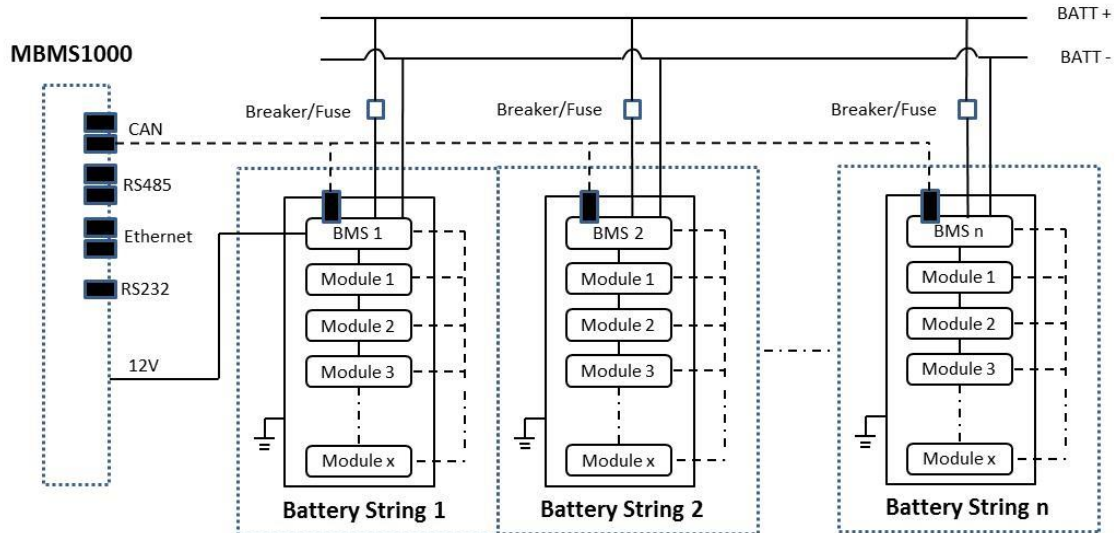

### 2.3.2 Diagram between BMS and battery modules

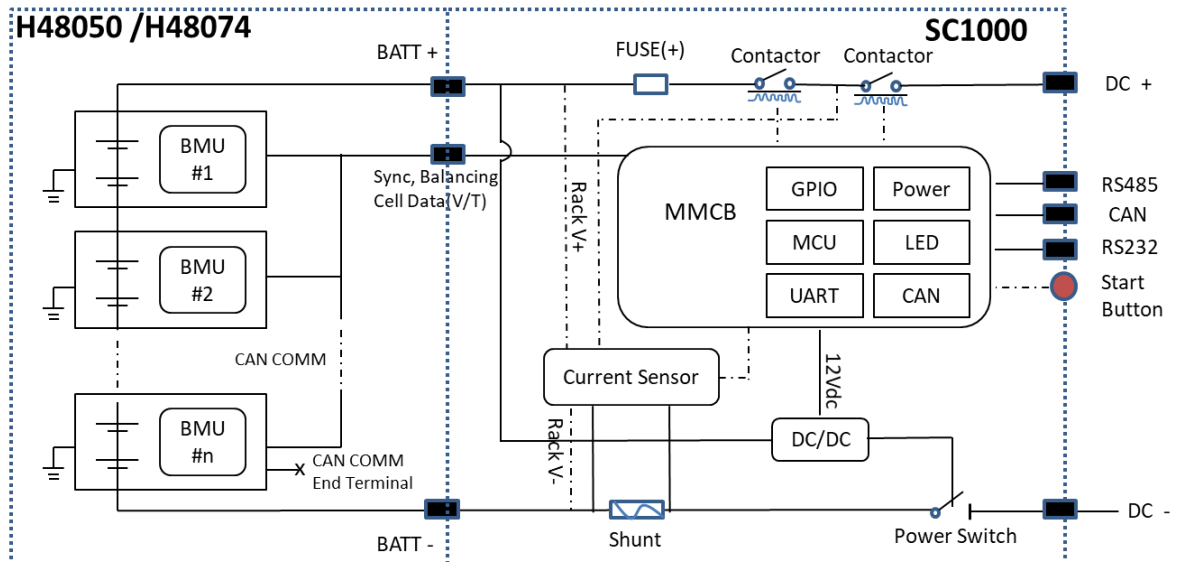



### 3. Installation

Please check every installation step in detail at <Annex 2: Installation and System Turn ON Progress List> during the install.

#### 3.1 Tools

The following tools are required to install the battery pack:

 <b>Wire Cutter</b>	 <b>Crimping Modular Plier</b>	 <b>Cable Ties</b>
 <b>Screw Driver Set</b>	 <b>Electric Screw Driver</b>	 <b>1000VDC Multimeter</b>
 <b>Adjustable Wrench</b>	 <b>Sleeve Piece</b>	

#### NOTE

Use properly insulated tools to prevent accidental electric shock or short circuits. If insulated tools are not available, cover the entire exposed metal surfaces with available insulated alternatives, except their tips, with electrical tape.

## 3.2 Safety Gear

It is recommended to wear the following safety gear when dealing with the battery pack.



Insulated gloves



Safety goggles



Safety shoes

## 3.3 System Working Environments Checking

### 3.3.1 Cleaning



The battery system has high voltage connectors. The clean condition will cause the isolation characteristic of the system.

Before installation and system working must clean the dust and iron scurf to keep the environments cleaning. And the environment must have certain anti-dust ability.

The system after long term running must check the humidity and dust cover or not. If heavy dust cover with high humidity on the system should stop the system running and make clean specially for the high voltage connectors.



**Danger:** the power cables and plugs will have high voltage DC power from serial connected battery modules (battery module can't be turned off), must be careful to handle the Power Plugs.

### 3.3.2 Temperature



PowerCube-H1/H2 system working temperature range: 0°C~50°C; Optimum temperature: 18°C~28°C.

**Caution:** Out of the working temperature range may cause the battery reduces the cycle of life even cause the battery system over / low temperature alarm or protection.

### 3.3.3 Cooling System



The room must be equipped with cooling system.

**Caution:** Out of the working temperature range may cause the battery reduces the cycle of life even cause the battery system over / low temperature alarm or protection.



### 3.3.4 Heating System

The room must be equipped with heating system. If the environment is lower than 0°C, must turn on the heating system at first.

**Caution:** Out of the working temperature range may cause the battery reduces the cycle of life even cause the battery system over / low temperature alarm or protection.



### 3.3.5 Fire-extinguisher System

The room must be equipped with fire-extinguisher system for lithium-ion battery.

The fire system needs to be regularly checked to be in normal condition. Refer to the using and maintenance requirements of local fire equipment relevant.



### 3.3.6 Grounding System

Before the battery installation must make sure the grounding point of the basement is stable and reliable. If the battery system is installed in an independent equipment cabin (e.g. container), must make sure the grounding of the cabin is stable and reliable.

**The resistance of the grounding system must  $\leq 100m\Omega$**

## 3.4 Package Items

### Accessories

The type and quantity of the accessories are subject to the battery packing list.

### NOTE

Power cable uses water-proofed connectors. It must keep pressing this Lock Button during pulling out the power plug.

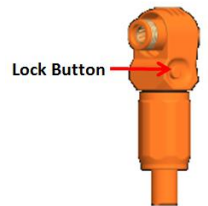

### Unpacking and check the Packing List:

- Cable kits include in Battery Controller carton box:

Power Cable + (Battery Module and Main Controller Serial Connection)	Orange/0.16m/4AWG/2 Orange Surlok Terminal	pcs	1pcs /module
--	--	-----	--------------

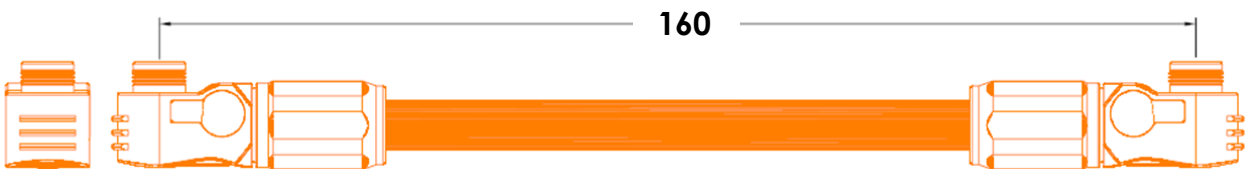

Power Cable - (Battery Module and Main Controller Serial Connection)	Black/2m/4AWG/2 Black Surlok Terminal	pcs	1pcs /system
--	---------------------------------------	-----	--------------

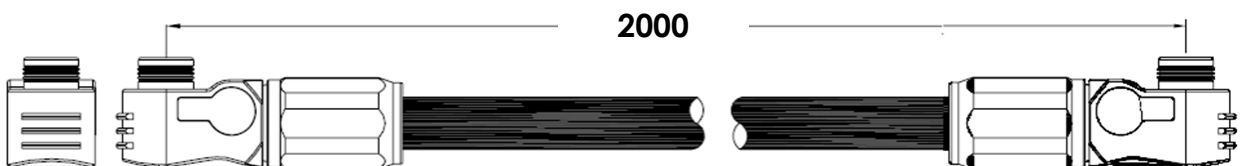

- Cable kits include in Battery Module carton box:

Power Cable (Battery Module Upper and Lower Serial Connection)	Orange/0.18m/4AWG/1 Orange & 1 Black Surlok Terminal	pcs	1pcs /system
--	--	-----	--------------

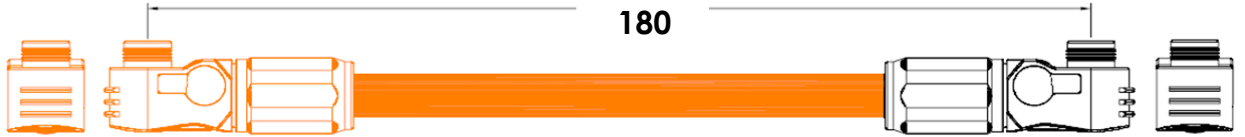

Battery Cascade Communication Cable (0.18m)	Black/0.18m/8 Core Super 5th Class Twisted-pair Wire/RJ45	pcs	1pcs /module
---	---	-----	--------------

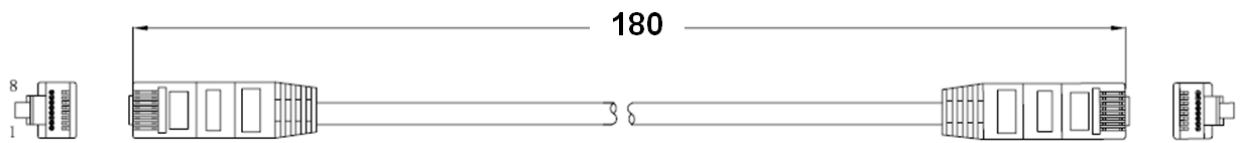

- Cable kits include in **EXTERNAL CABLE KITS(order separately)**:

External Battery CAN Communication Cable (direct)	Black/3.5m/Super 5th Class Twisted-pair Wire/2 RJ45 terminal	pcs	1 pcs /system
--	---	-----	------------------

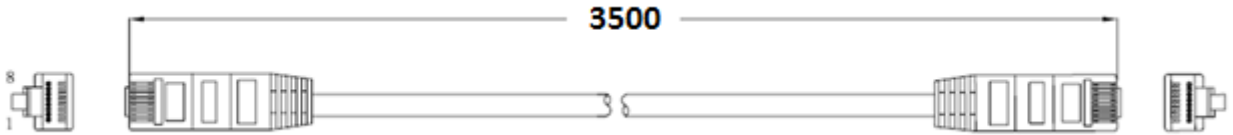

External Power Cable +	Orange/2m/4AWG/SURLOK Terminal/25-8 Terminal	pcs	1
------------------------	---	-----	---



External Power Cable -	Black/2m/4AWG/SURLOK Terminal/25-8 Terminal	pcs	1
------------------------	--	-----	---

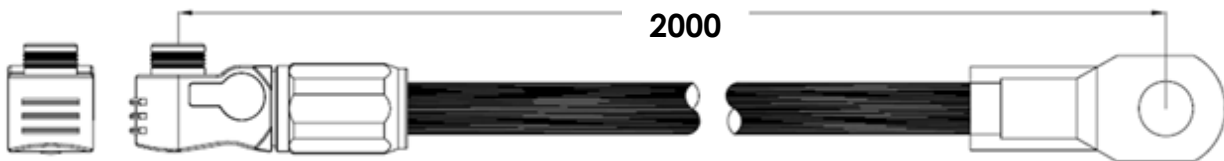

### 3.5 Handling and placement



**Warning:** The battery rack is IP00. It must be installed in a restricted access area;

**Warning:** PowerCube-H1/H2 is a high voltage DC system, operated by qualified and authorized personnel only.



#### 3.5.1 Handling and placement of the battery module

Single battery module for H48050/H48074 is 24kg/32kg. If without handling tools must have more than 1 man to handling with it.

#### 3.5.2 Handling and placement of the rack

If without handling tools must have more than 4 men to handling with it.

#### 3.5.3 The fix and installation of the rack

The rack must be fixed on the basement and carriage on the wall with M10 screws.

**Battery rack basement holes bitmap (unit: mm):**

**Battery rack wall fixed holes bitmap (unit: mm):**

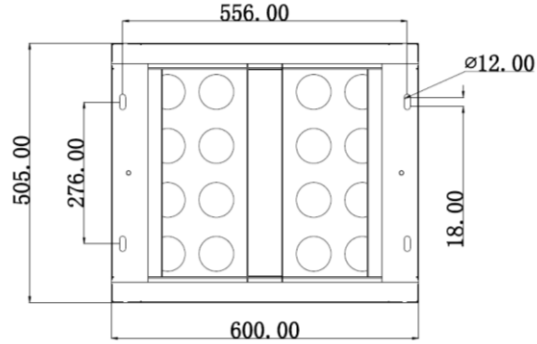

**3.5.4 Control Module (BMS) and all Battery Modules install into the Rack**

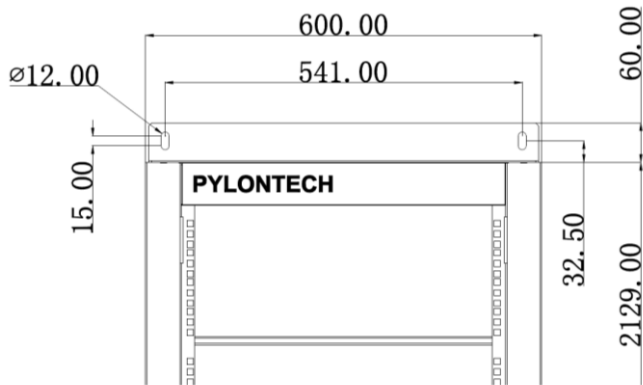

- Install the **buckle nuts**. The position of nuts must meet the position of the control module (BMS) and all battery modules.
- Install the control module (BMS) and all battery modules in. Each module uses 4 **screws** to fix.



**3.5.5 Install the MBMS into a 19' standard rack [On the top of BMS, or use the rack configured by user]**

- Install the **buckle nuts**. The position of nuts must meet the position of the MBMS.
- Install the MBMS in. Uses 4 **screws** to fix.



### 3.6 Cables connection

#### 3.6.1 Attention:



**Danger:** The battery system is high voltage DC system. Must make sure the grounding of the rack is stable and reliable.



**Danger:** All the plugs and sockets of the power cables must be **orange to orange and black to black**. Otherwise it will cause personal injury.



**Danger:** An Isolation breakers or switches for both positive and negative conductors between each battery string and inverter must be installed for maintenance.

**Danger:** No short circuit or reserved connection of the battery system's anode and cathode.



**Caution:** Wrong communication cables connection will cause the battery system failure.

#### Grounding



The PowerCube-H1/H2 modules' grounding is based on metal directly touch between the module's surface and rack's surface. So it don't need grounding cables at all. If uses normal rack, it should remove the paint at the corresponding grounding point.

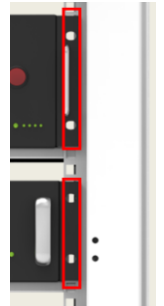

#### Rack Grounding:

If there is a grounding metal frame outside the rack, for example, the metal angle steel frame at the bottom of the container, the fix hole of the fix frame can be fixed directly with the metal frame of the container. Then through the grounding of the container to ensure reliable grounding.

The cable shall be copper with yellow-green color.

If want to connect the ground cable, it can be connected to the M8 grounding bolt on the frame base. Grounding cable must  $\geq 6\text{AWG}$ .

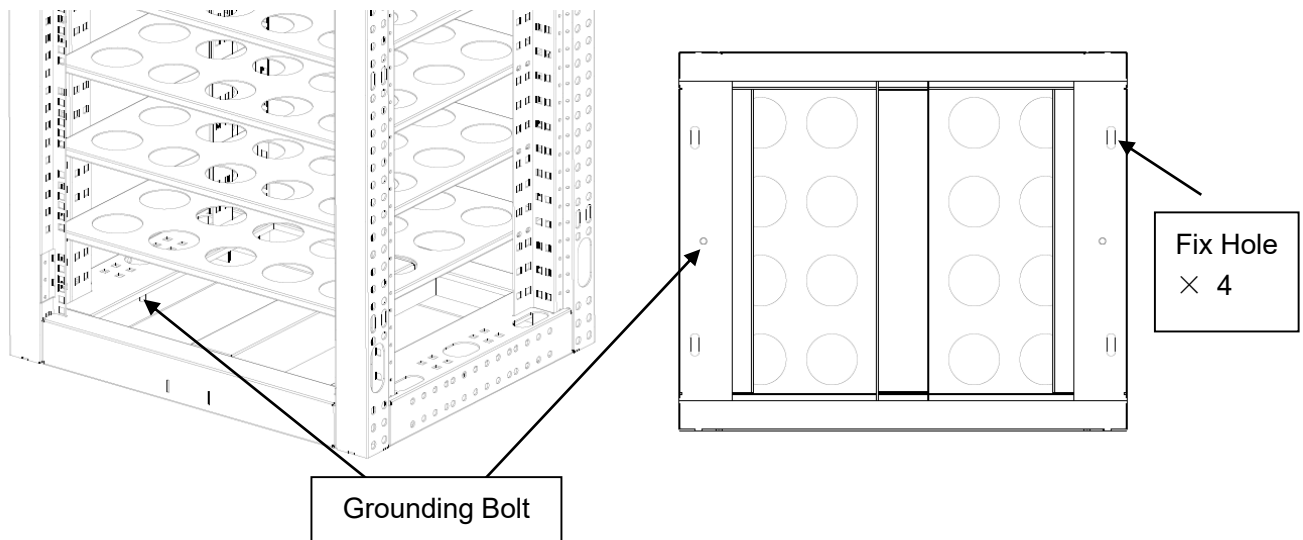

### 3.6.2 Power and communication cable Connection

**Note:** Power cable uses water-proofed connectors. It must keep pressing this Lock Button during pulling out the power plug.

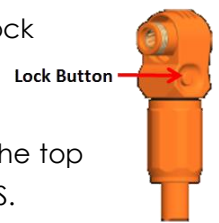

If there are more than 1 rack of PowerCube-H1/H2, there will require a MBMS on the top which aggregate information from all the BMS and communicate with inverter/PCS.

#### CAN Communication Mode between MBMS and BMS (battery string qty. ≤ 6 sets)

When system configured PowerCube-H1/H2 ≤ 6 sets. The communication between PowerCube-H1/H2s uses CAN cascade communication mode. The communication between the MBMS and the BMS of 1<sup>st</sup> PowerCube-H1/H2 uses CAN communication mode

### CAN Communication Mode between MBMS and BMS Cable Diagram:



**Note:** The 1<sup>st</sup> PowerCube-H1/H2 should be installed nearest to the MBMS.

#### 3.6.3 ADD Switch Setting (Address Assignment)

**ADD Switch BMS** is a 6 bit dial switches to manually distribute the communication address of the battery system. Nether position is OFF, means "0". Upper position is ON, means "1". 1<sup>st</sup> bit to 5<sup>th</sup> bit is for address, and the 6<sup>th</sup> bit dial switch support a 120  $\Omega$  resistance (**Terminal Resistance**).



ADD Switch MBMS is a 6 bit dial switches to manually distribute the communication address of the battery system. Nether position is OFF, means "0". Upper position is ON, means "1". 1st bit to 4th bit is for address, the 5th and the 6th bit dial switch support a 120  $\Omega$  resistance (**Terminal Resistance**).



### 3.6.3.1 Under communication for single BMS (battery string qty. 1 set)

The BMS's first five bits must set in below <**BMS's Address Configure Table**>. The last BMS's terminal resistance must set in "1" (X=1);

**The address is configured follow ASCII code: ("X" is terminal resistance).**

**BMS's Address Configure Table:**

CAN	Modbus	Address dial bit
0	1	00000X
1	1	10000X
2	2	01000X
3	3	11000X
4	4	00100X
5	5	10100X
6	6	01100X

### 3.6.3.2 Under CAN Communication Mode between MBMS and BMS (battery string qty. $\leq 6$ set)

The BMS's first five bits must set in below <**BMS's Address Configure Table**>. The last BMS's terminal resistance must set in "1" (X=1), and other BMS's terminal resistance must set in "0".

**The address is configured follow ASCII code: ("X" is terminal resistance).**



**BMS's Address Configure Table:**

The MBMS's ADD Switch set with "000011".

The last 2 bits are terminal resistances.

Note: the 1<sup>st</sup> to 4<sup>th</sup> bit dial for MBMS refer to 3.6.3.3

Battery String	Address Bit
1	10000X
2	01000X
3	11000X
4	00100X
5	10100X
6	01100X

### 3.6.3.3 Multi MBMS Communication Mode

In some project it configures multi Energy Storage Systems. In this case will have multi MBMS. The address of MBMS must follow <MBMS's Address Configure Table>

CAN	MODBUS	address dial bit 1~4
0	1	0000
1	1	1000
2	2	0100
3	3	1100
4	4	0010
5	5	1010
6	6	0110
7	7	1110
8	8	0001
9	9	1001
10	10	0101
11	11	1101
12	12	0011
13	13	1011
14	14	0111
15	15	1111

### 3.6.4 System turns on



Double check all the power cables and communication cables. Make sure the voltage of the PCS is same level with the battery system. Check all the power switch of every battery system is OFF.



**Warning:** MBMS must be turned on after all battery strings self-check finish.

**Warning:** The external switch or breaker between PCS and battery string must be off before the battery system power on.

#### System turns on step:

- (1) Switch the external power or inverter/PCS on, to make sure all the power equipment can work normally.
- (2) Confirm the MBMS **is off**.
- (3) Turn on all the BMS (Battery Control Modules) as follow step:  
 Turn on the 1<sup>st</sup> BMS (Battery Control Modules) of battery string:  
 The second BMS must be operated after the first battery string's self-check is successful.  
 From 1<sup>st</sup> BMS to the last BMS Then turn on the battery strings on one by one.

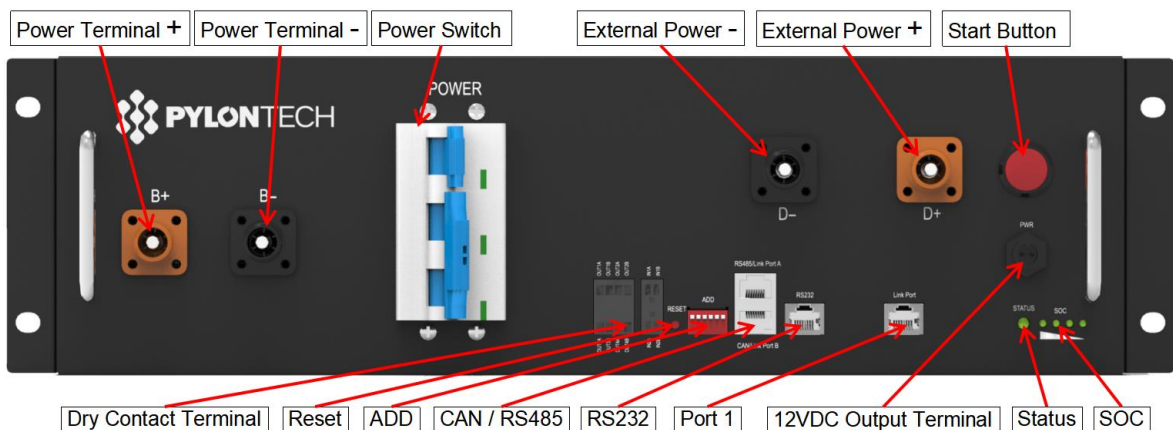

- 1. Turn on the "POWER SWITCH":



**Warning:** Due to the BMS positive pole internally do not contains isolating switch or breaker, only fuse and relay. The mains circuit cannot be manually cut-off while in power on stage. It's mandatory to cut off the isolating switch or breaker externally firstly for safety concern.



**Caution:** The time interval between every time switch OFF/ON the "Power Switch" shall **>3 minutes**.

**Caution:** When the breaker is tripped off because the system has over current or short circuit, must **after 30min** to turn on it again, otherwise may cause the breaker damage.



- 2. Turn on the "Start Button":  
Press and hold the Start Button for more than 5sec until the buzzer rings, the LED indicator on front panel will light on if the start-up is successful.



**Caution:** Do not press the start button more than 30s continuously, or it will go into "BLACK-

**START"** mode.



开机：长按至蜂鸣器响

**Power on:** Press and hold **≥5sec** till the buzzer rings

- System start process:  
The battery string's system will check itself, if work normal the battery string system will go to self-check mode.  
If the BMS and all battery modules are working normally, every status LED will lighting green, that's mean self-check are pass. Self-check will be finish within 30sec.

Black-start function:

If long press(>5sec) the start button 30s **AFTER** power on. The "STATUS" lamp will becomes green if the black start function is enabled. If "STATUS" lamp remain red, the black start function is failed to active, need long press start button again. System will close relay and output for 10mins.

If MBMS is using internal power supply from BMS, after all BMS powered on please first use black start function to provide power supply to MBMS, for further establish the external communication.

**Note:** If there is no communication from upper equipment because of the communication is off, the "STATUS" lamp will light red after 30sec. That doesn't mean failure existed, it means this battery string is OK while the external communication is off.



**Warning:** If has failure during the self-check, must debug the failure then can start next step.

If the "STATUS" lamp shows red from beginning, it means has failure in the battery string, the Power Relays in BMS will switch ON, must debug at first.



**Caution:** During first time power on, the system will require to do fully charge progress for SOC calibration purpose.



**Caution:** The whole Battery Energy Storage System (BESS) after installation or restart the system when long time not in using should charge it to full at first. There will be a regularly fully charge requesting during continuous operation as well, it will be handled automatically by the communication between BESS and external device.



**Warning:** if the black-start function is used, the terminal of DC "+" and DC "-" will be electricity dangerous with high DC voltage output.

(4) Switch the MBMS on after all the BMS turn on successful:

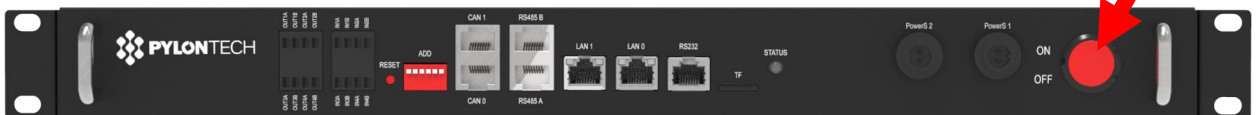

And check whether MBMS is working. The "STATUS" lamp will light green.

When the voltage difference between strings is smaller than the parameter, the battery string will do the parallel operation. Then the power relays in BMS will switch ON after 30 seconds. The "STATUS" lamp of the BMS will light green;

When the voltage difference between strings is bigger than the parameter, the battery string will NOT do the parallel operation, the "STATUS" lamp of the BMS will light red, but it is normal; Such battery string will be paralleled in during charging stage automatically.

**Note:** If there is no communication between MBMS and upper controller, the system can't work normally. External device should communicate with battery system through LAN, CAN or MODBUS RTU. Otherwise maybe cause battery system work abnormal.



**Caution:** During first time power on, the system will require to do fully charge progress for SOC calibration purpose.

**Caution:** The whole Battery Energy Storage System (BESS) after installation or restart the system when long time not in using should charge it to full at first.

There will be a regularly (3 month) fully charge requesting during continuous operation as well, it will be handled automatically by the communication between BESS and external device.

### 3.6.5 System turns off

When failure or before service, must turn the battery storage system off:

- (1) Soft-off the PCS through PCS's control panel.
- (2) Turn off the switch between PCS and battery string (PowerCube-H1/H2), or turn off the power switch of PCS, to make sure no current transmission through battery string and PCS.
- (3) Turn off the "Power Switch" of the BMS.

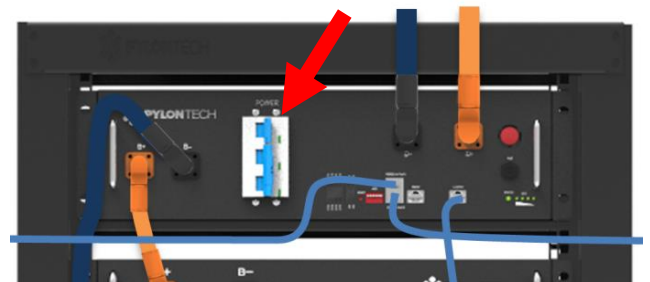

- (4) Turn off the "Power Switch" between BMS and inverter.
- (5) Turn off the "Power Switch" of the MBMS. If the BESS configures only single battery string without MBMS, then ignore this operation step.



- (6) Turn off the UPS if configured.

The UPS can turn on if have equipment must keep running. Otherwise suggest turn off the UPS to save its power.



**Caution:** Before change the battery module for service, must charge/discharge the replaced battery to same voltage as the other modules in the system. Otherwise system needs long time to do the balance for such replacement module.





**Warning:** Do not turn off the “**Power Switch**” during normal running condition. Otherwise will cause this battery string current surge by another battery strings. If turned off the “**Power Switch**” in normal running condition, must first turn off the PCS.

#### NOTE

**After installation, DO NOT forget to register online for full warranty:**

[www.pylontech.com.cn/service/support](http://www.pylontech.com.cn/service/support)

## 4. System Debug

**This system debug is for BESS system (Battery Energy Storage System). BESS system can't do the debug itself. It must operation with configured UPS, PCS and EMS system together.**

Debug Step	Content
Prepare of debug.	Turn on the BESS system, refer to chapter 3. Before turn on the whole BESS system turn on the load is <b>not allowed!</b> Remark: Except the BESS, if other equipment have its own system turn on step, must follow its own system operation manual.
System function test.	Each component system debug: <b>Power supply</b> Check if the External Power Supply (e.g. UPS) is working normally. <b>Communication Test:</b> Check the communication between the BESS system and communicated devices normal or not, has alarm or not. <b>Power Conversion System Test:</b> Before conjoint test must test the Inverter System turn on progress at first. And check the parameters meet BESS requirement or not. <b>BESS Test:</b> Charge/Discharge test; Test stop charging, stop discharging, current limiting functions, etc. <b>Caution:</b> Before turn on the BESS system must setup all the parameters of the PCS and EMS at first.
Monitor function test. (If configured.)	Check whether the data of the BESS system is showing on the monitor system normally.
EMS conjoint test (If configured.)	If the EMS system has running monitor requirements, check if the BESS system is following EMS instructions.
Trial operation test.	After the system debugged, run the system a period as test (testing with low load), to test the high voltage DC system is fit for the contract.

## 5. Maintenance

### 5.1 Trouble Shooting:



**Danger:** The PowerCube-H1/H2 is a high voltage DC system, operated by qualified and authorized person only.



**Danger:** Before check the failure, must check all the cables connection and the BESS system can turn on normally or not.

No	Problem	Possible Reason	Solution
1	Turn on the BMS. All battery modules' status LED is not working.	<ul style="list-style-type: none"> <li>● The DC/DC power board or control board is failure.</li> <li>● The communication cable from BMS to the first battery module is broken</li> <li>● Power cable is broken;</li> </ul>	<ul style="list-style-type: none"> <li>● Change the control module (BMS module).</li> <li>● Change the broken communication cable;</li> <li>● Check all the power cables and connections are fine or not;</li> </ul>
2	Turn on the BMS. The Status LED for BMS is not working. But all battery modules' status LED is lighting green.	<ul style="list-style-type: none"> <li>● The control board is failure.</li> </ul>	<ul style="list-style-type: none"> <li>● Change the control module (BMS module).</li> </ul>
3	Turn on the BMS. The Status LED is lighting red. But all battery modules' status LED is lighting green.	<ul style="list-style-type: none"> <li>● This battery string is under protection. It is possible Over Current Protection or Failure Protection.</li> <li>● No external communication with upper controller;</li> <li>● Battery String is reversed connection.</li> </ul>	<ul style="list-style-type: none"> <li>● Through the monitor or maintenance software check the battery cell, battery module has alarm or not.</li> <li>● Check communication with upper controller and communication cable wiring;</li> <li>● <b>Reversed connection is serious danger!</b></li> </ul>
4	The BMS's Status LED is lighting red and some the battery module's status LED is lighting green but some is lighting red.	<ul style="list-style-type: none"> <li>● This battery string is under protection. It is possible Over Current, Over Voltage, Low Voltage, Over Temperature, Low Temperature or Failure Protection.</li> </ul>	<ul style="list-style-type: none"> <li>● Use the monitor or maintenance software to check the battery cell, battery module has protection and failure or not.</li> </ul>

5	Cannot close the power Switch.	<ul style="list-style-type: none"> <li>● DC Output breaker is fault.</li> </ul>	Check the DC output breaker is fault or not. If it is fault, change the control module (BMS module).
6	Open the Power Relay Switch, but the relay can't be open.	<ul style="list-style-type: none"> <li>● The main control board is failure.</li> <li>● The wire of the output relay, or the wire of the power relay switch in the BMS is broken</li> </ul>	<ul style="list-style-type: none"> <li>● Change the control module (BMS module).</li> <li>● Check the wire got loose or broken? Fix it. Or the control module (BMS module).</li> </ul>
7	Turn on the BMS. The Status LED is flashing red.	Self-check can't pass.	If something is wrong, please contact with seller or sells agent.
8	Turn on the BMS. The Status LED is lighting red. And the buzzer is noising.	<ul style="list-style-type: none"> <li>● Output relay is non-separable switching.</li> <li>● The buzzer is failure ;</li> <li>● Output relay False alarm;</li> </ul>	<ul style="list-style-type: none"> <li>● Check the output relay. If fault find out the short circuit reason. Change the relay or the control module (BMS module).</li> <li>● Change the control module (BMS module).</li> </ul>
9	Turn on the BMS. The Status LED shows normal. But the output relay can't be actuation.	<ul style="list-style-type: none"> <li>● The wire of the output relay or the wire of the power relay switch in the BMS is broken.</li> <li>● Power Relay Switch is open;</li> </ul>	<ul style="list-style-type: none"> <li>● Check the wire got loose or broken? Fix it. Or change the control module (BMS module).</li> <li>● Close the Power Relay Switch.</li> </ul>
10	Turn on the BMS. The one and the following of the battery module's Status LED lighting red or not lighting.	<ul style="list-style-type: none"> <li>● This battery module has failure;</li> <li>● Its communication cable failure;</li> <li>● Its Address Distribution failure.</li> </ul>	<ul style="list-style-type: none"> <li>● Change this battery module;</li> <li>● Check the communication cable;</li> <li>● Check by professional stuff.</li> </ul>
11	Single Cell is over voltage/ low voltage. (Check through the monitor or maintenance software.)	<ul style="list-style-type: none"> <li>● Cell voltage sampling failure.</li> <li>● Cell failure;</li> </ul>	<ul style="list-style-type: none"> <li>● Check the wires of cell sampling module;</li> <li>● Change this battery module.</li> </ul>
12	Battery module shows the temperature is -40°C. (Check through the monitor or maintenance software.)	The wires of temperature sampling failure.	Check the wires of temperature sampling module. Or change this battery module.
13	Another failure	Cell failure or electrical board failure.	Can't find out failure point or can't check. Please contact with distributor or Pylontech.

## 5.2 Replacement of main component



**Danger:** The PowerCube-H1/H2 is a high voltage DC system, operated by qualified and authorized person only.

**Danger:** Before replace the main component must shut off the maintenance battery string's power. Must confirm the **D+** and **D-** terminal are without power. The turn off progress refer to chapter 3.6.5.

### 5.2.1 Replacement of Battery Module

5.2.1.1 Use a charger to charge the new battery module and existing module to full (SOC 100%)

5.2.1.2 Turn off the whole battery string's power. Must confirm the **D+** and **D-** terminal are without power. The turn off progress refer to chapter 3.6.5.

5.2.1.3 Pull out the Plug of Power Cable +/- . Pull out the plug of communication cable.

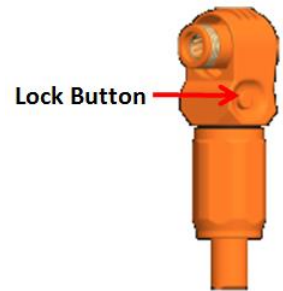

**Danger:** the power cables and plugs still have high voltage DC power from serial connected battery modules (battery module can't be turned off), must be careful to handle the Power plugs.

5.2.1.4 Dismantle the 4 screws of the battery module's front face.



5.2.1.5 Handle the battery module out of the rack, and put it to the appoint place.



**Warning:** Single battery module is 24kg/32kg. If without handling tools must more than 1 personnel to handling with it. If install in high place of the rack it must more than 2 personnel.

5.2.1.6 Install the new battery module (see before 5.2.1.1). And connect the cables. Refer to chapter 3.5.

5.2.1.7 Turn on this battery string. Refer to chapter 3.6.

## 5.2.2 Replacement of Control Module (BMS)

5.2.1.1 Turn off the whole battery string's power. Must confirm the **D+** and **D-** terminal are without power. The turn off progress refer to chapter 3.6.5.

5.2.2.2 Pull out the plugs of Power Cables and the communication plugs.



**Danger:** the power cables still have high voltage DC power from another battery modules, must be careful to handle the Power plugs.

5.2.2.3 Dismantle the 4 screws of the battery module's front face.



5.2.2.4 Install the new control module (BMS). And reconnect all the cables. Refer to chapter 3.5.

5.2.2.5 Turn on this battery string. Refer to chapter 3.6.



**Caution:** Before pull out the communication cables must mark the cable number, to avoid cable wrong sequence.

### 5.2.3 Replacement of 3<sup>rd</sup> level Control Module (MBMS)

5.2.3.1 Turn off the Power Switch. Refer to chapter 3.6.5.



**Caution:** Turn off this MBMS will stop the power output of belonging whole Battery Energy Storage System.

5.2.3.2 Dismantle the 4 screws.

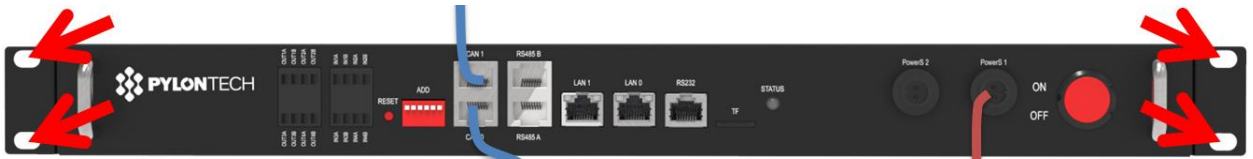

5.2.3.3 Install the new MBMS inside. And reconnect the cables. Refer to chapter 3.5.

5.2.3.4 Turn on this MBMS. Refer to chapter 3.6.



**Caution:** Before pull out the communication cables must mark the cable number, to avoid cable wrong sequence.



## 5.3 Battery Maintenance

**Danger:** The maintenance of battery must done by qualified and authorized personnel only.

**Danger:** Some maintenance items must turn off at first.

### 5.3.1 Voltage Inspection:

**[Periodical Maintenance]** Check the voltage of battery system through the monitor system. Check the system abnormal voltage or not. For example: Single cell's voltage is abnormal high or low.

### 5.3.2 SOC Inspection:

**[Periodical Maintenance]** Check the SOC of battery system through the monitor system. Check the battery string abnormal SOC or not.

### 5.3.3 Cables Inspection:

**[Periodical Maintenance]** Visual inspect all the cables of battery system. Check the cables has broken, aging, getting loose or not.

### 5.3.4 Balancing:

**[Periodical Maintenance]** The battery strings will become unbalance if long time not be full charged. Solution: every 3 month should do the balancing maintenance (charge to full), normally it will be done automatically by the communication between system and external device.

### 5.3.5 Output Relay Inspection:

**[Periodical Maintenance]** Under low load condition (low current), control the output relay OFF and ON to hear the relay has click voice, that's mean this relay can off and on normally.

### 5.3.6 History Inspection:

**[Periodical Maintenance]** Analysis the history record to check has accident (alarm and protection)

or not, and analysis its reason.

### **5.3.7 Shutdown and Maintenance:**

#### **[Periodical Maintenance]**

Some system function must be maintenance during the EMS restart, it is recommended to maintenance the system every 6 months.

### **5.3.8 Recycle**

#### **NOTE**

Damaged batteries may leak electrolyte or produce flammable gas.

In case a damaged battery needs recycling, it shall follow the local recycling regulation (i.e. Regulation (EC) N° 1013/2006 among European Union) to process, and using the best available techniques to achieve a relevant recycling efficiency.

## **6. Remarks**

### **Storage recommendation**

For long-term storage (more than 3 months), the battery cells should be stored in the temperature range of 5~45°C, relative humidity <65% and contains no corrosive gas environment.

The battery module should shelved in range of 5~45°C, dry, clean and well ventilated environment. Before storage the battery should be charged to 50~55% SoC;

It is recommended to active the chemical (discharge and charge) of the battery every 3 months, and the longest discharge and charge interval shall not exceed 6 months.



Caution: If not follow the above instructions for long term store the battery, The cycle life will have relative heavily reduction.

### **Capacity expansion**

A new battery module can be add onto an existing system at any time. Please make sure the existing system is being fully charged before add on a new module. In a serial connection system, the new module, even has a higher SOH, will follow the system worst SOH condition module to perform.

## **7. Shipment**

Battery module will pre-charged to 100% SOC or according to customer requirement before shipment. The remaining capacity of battery cell, after shipment and before charge, is determined by the storage time and condition.

1. The battery modules meet the UN38.3 certificate standard.
2. In particular, special rules for the carriage of goods on the road and the current dangerous goods law, specifically ADR (European Convention on the International Carriage of Dangerous Goods by Road), as amended, must be observed.

# Annex 1: Cable connection diagram

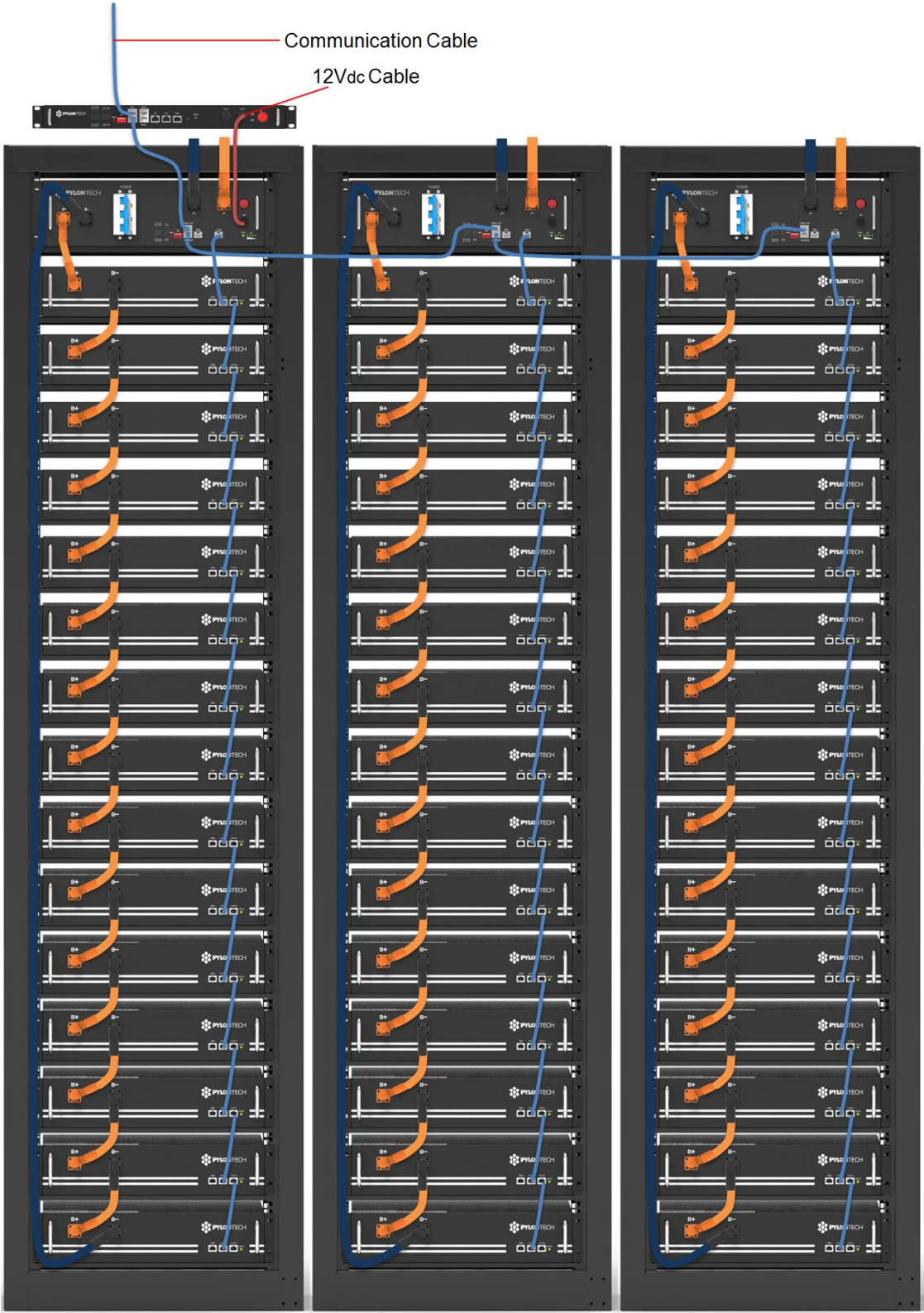



## Annex 2: Installation and System Turn ON Progress List

Tick after completion	No.	Item	Remark
<input type="checkbox"/>	1	The environment is meeting all technical requirements. 3.3.1 Cleaning 3.3.2 Temperature 3.3.3 Radiating System 3.3.4 Heating System 3.3.5 Fire-extinguisher System 3.3.6 Grounding System	Refer to chapter 3.3
<input type="checkbox"/>	2	Battery rack is installed follow the technical requirements.	Refer to chapter 3.5.3.
<input type="checkbox"/>	3	Control Module (BMS) and Battery Module are installed well.	Refer to chapter 3.5.4.
<input type="checkbox"/>	4	The MBMS are installed well. (If configured.)	Refer to chapter 3.5.5.
<input type="checkbox"/>	5	Connect <b>External Power Cable +/-</b> between each BMS to the PCS or confluence cabinet.	Refer to chapter 3.6.2.
<input type="checkbox"/>	6	Connect power cables of each battery string.	Refer to chapter 3.6.2.
<input type="checkbox"/>	7	Connect communication cables of each battery string.	Refer to chapter 3.6.2.
<input type="checkbox"/>	8	Set up ADD switch of every BMS and the MBMS (Address Assignment).	Refer to chapter 3.6.3.
<input type="checkbox"/>	9	Connect external communication cables from BMS to BMS, MBMS, inverter, PCS or another.	Refer to chapter 3.6.2.
<input type="checkbox"/>	10	Connect the communication cable from MBMS to the PCS.	Refer to chapter 3.6.2.
<input type="checkbox"/>	11	Double check every <b>power cables, communication cables</b> installed well. And <b>ADD Switches</b> are setting right.	Refer to chapter 3.6.2 and 3.6.3.

<input type="checkbox"/>	12	Check the UPS is turned on. And the UPS is power supplying. (If configured)	Refer to chapter 3.6.4.
<input type="checkbox"/>	13	Switch the external power or PCS on, to sure all the power equipments can work normally.	Refer to chapter 3.6.4.
<input type="checkbox"/>	14	<p>Turn the BMS (Battery Control Modules) of each battery string on (from 1<sup>st</sup> BMS to the last, one by one)</p> <ul style="list-style-type: none"> <li>● Turn on the “Power Switch”:</li> <li>● Turn on the “Start Button”:</li> <li>● The battery string’s system will check itself, if work normal the battery string system will goes into self-check mode.</li> </ul> <p>If has failure during the self-check, must debug the failure then can start next step.</p>	Refer to chapter 3.6.4.
<input type="checkbox"/>	15	<p>If every battery string are working normally.</p> <p>Then <b>switch the MBMS on</b>. The MBMS will self-check and check each battery string one by one.</p>	Refer to chapter 3.6.4.
<input type="checkbox"/>	16	<p>The first installation should do full charging progress.</p> <p>After MBMS has communicated with each BMS, it will run parallel operation. It will begin from lowest voltage battery string to do the parallel operation during the charging.</p> <p>If the status LED of BMS turns to green, it means this battery string is in parallel operation.</p>	The first installation should do full charging progress.

### Annex 3: System Turn OFF Progress List

Tick after completion	No.	Item	Remark
<input type="checkbox"/>	1	Soft-off the PCS through PCS's control panel.	Refer to chapter 3.6.5.
<input type="checkbox"/>	2	Turn off the switch between PCS and this battery string (PowerCube-H1/H2), or turn off the power switch of PCS, to make sure no current through this battery string.	Refer to chapter 3.6.5.
<input type="checkbox"/>	3	Turn off all the "Power Switch" of the BMS.	Refer to chapter 3.6.5.
<input type="checkbox"/>	4	Turn off the "Power Switch" of the MBMS.	Refer to chapter 3.6.5.
<input type="checkbox"/>	5	Turn off the UPS. (If configured.) <ul style="list-style-type: none"> <li>• The UPS can turn on to check the equipment (PCS or battery system etc.). Otherwise must turn off the UPS to save its power.</li> </ul>	Refer to chapter 3.6.5.



**PYLONTECH**

**Pylon Technologies Co., Ltd.**

No. 73, Lane 887, ZuChongzhi Road, Zhangjiang Hi-Tech Park  
Pudong, Shanghai 201203, China

**T**+86-21-51317699 | **F** +86-21-51317698

**E** [service@pylontech.com.cn](mailto:service@pylontech.com.cn)

**W** [www.pylontech.com.cn](http://www.pylontech.com.cn)